

PRODUCT DATA SHEET



PRODUCT CODE

CV6000SG

RANGE

CANVASS

DESCRIPTION

Basin Unit 600mm Storm Grey

COLOUR	Storm Grey
COLOUR CODE/ REFERENCE	NCS S 3502-Y
MATERIAL	16 and 18mm MDF Solvent Free Acrylic Lacquer
STANDARDS	EN 13986 EN 14749
INSTALLATION TYPE	Floor Standing with Legs or Wall Hung
DRAWER BOX	Self Coloured to Carcass Concealed Runners
DRAWER RUNNERS	Emuca Silver - Soft Close, Pull to Open
DRAWER EXTENSION	Full Extension
DRAWER ADJUSTMENT	3 Way
DRAWER CAPACITY	30kg
WALL HANGERS	ITALIANA FERRAMENTA Libra 11 With Safety Lock - Factory Fitted Load Capacity 200kg Per Pair On A Solid Wall 3 Way Adjustment
ADJUSTABLE FEET	Yes
WARRANTY	10 Years

TECHNICAL DIMENSIONS

Dimensions in mm unless otherwise specified.

Tolerances (per material type) apply.

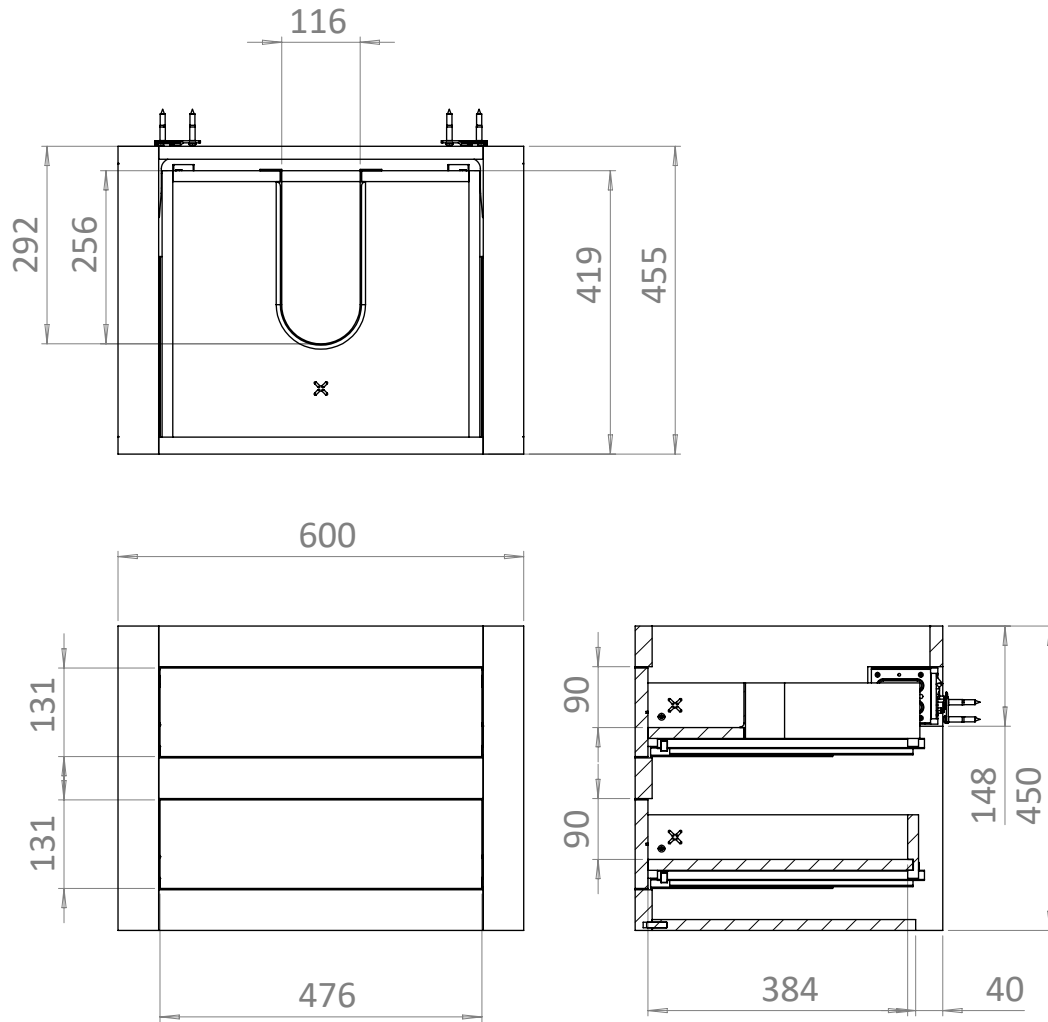

V10522

SPARES DIAGRAM

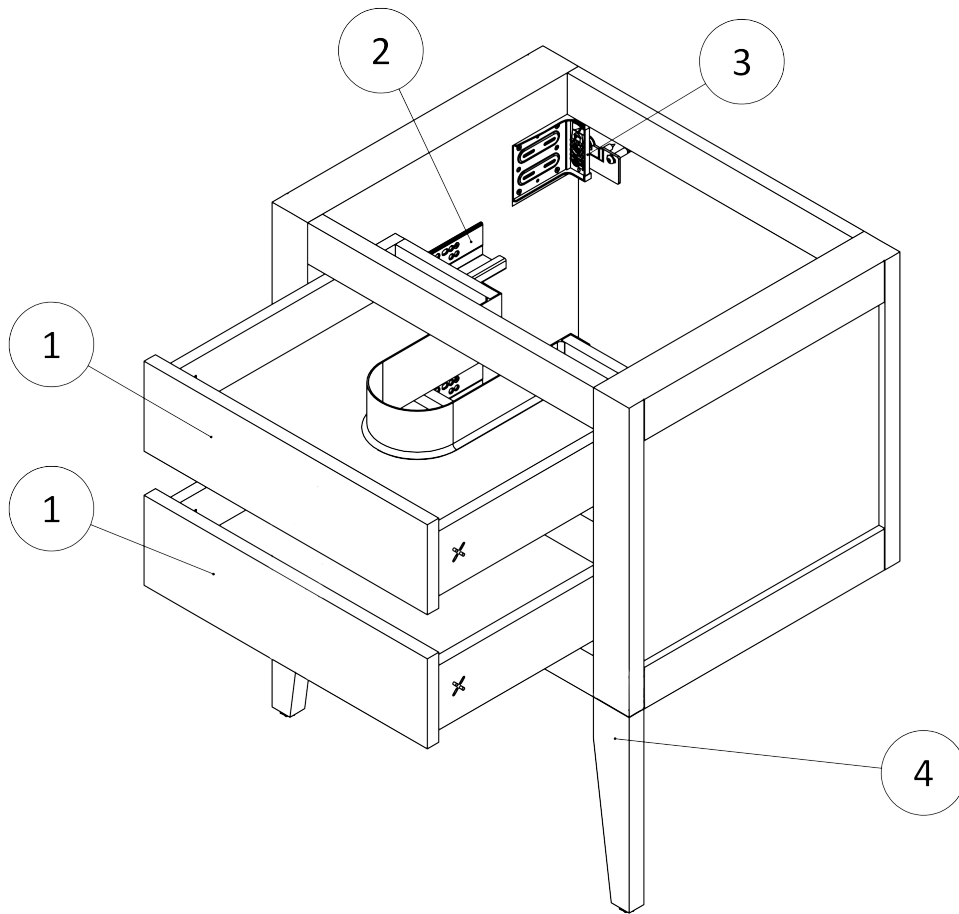

NUMBER	PART CODE	DESCRIPTION
1	DF_CV6000WG	Canvass Drawer Front - Gloss White
	DF_CV6000IB	Canvass Drawer Front - Indigo Blue
	DF_CV6000SG	Canvass Drawer Front - Storm Grey
	DF_CV6000SGR	Canvass Drawer Front - Sage Green
2	RUNNERSCANVASS	Set of Drawer Runners x2 Canvass Depth 455mm
3	WBRACKETSCANVASS	Wall Brackets x2 Canvass
4	LEGISNTALL_CANVASS	Canvass Leg Install kit

V10522