

ACE

2-hole washbasin mixer, with swivel spout
Miscelatore 2 fori da lavabo, con bocca girevole
Mitigeur 2-trous de lavabo, avec bec mobile
2-Loch-WaschtischBatterie, mit Schwenkauslauf
Monomando de lavabo de 2 agujeros, con caño giratorio
Wastafelmengkraan 2-gats met draaibare uitloop, zonder waste













hotbath
italian bathroomware

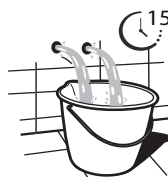

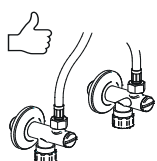
AC023

AC023H

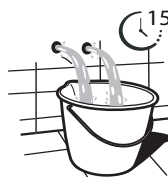
BEFORE STARTING / PRIMA DI INIZIARE / AVANT DE COMMENCER / ANTES DE EMPEZAR / VOR DEM START / VOORDAT JE BEGINT

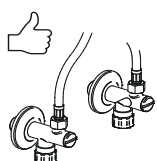
 P bar	 MAX 5 1 MIN	 3 1 MIN		 15s		 FILTER TAPS RECOMMENDED
 T °C	 MAX 80	 60 45				

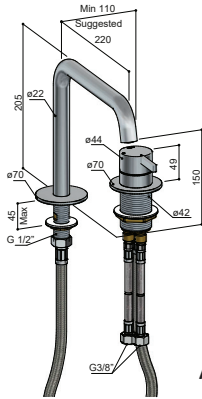

AC023

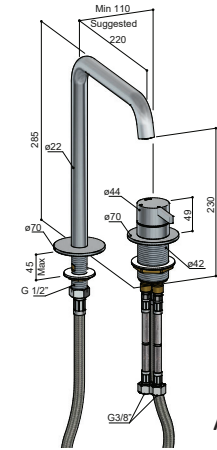

AC023H

1

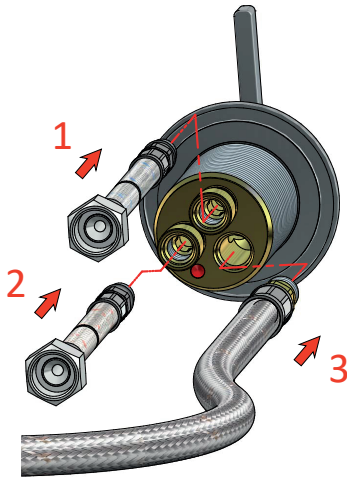

2

INSTALL THE MIXER BODY IN COLD START POSITION

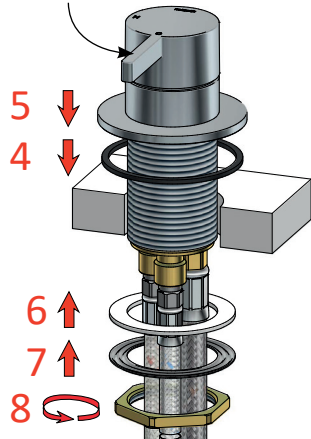

3

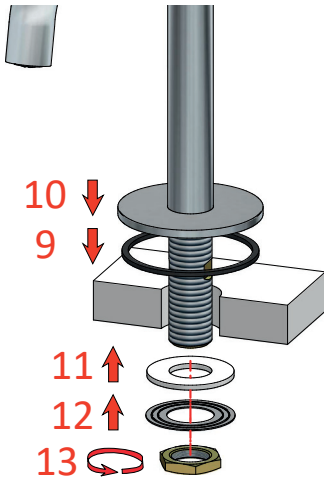



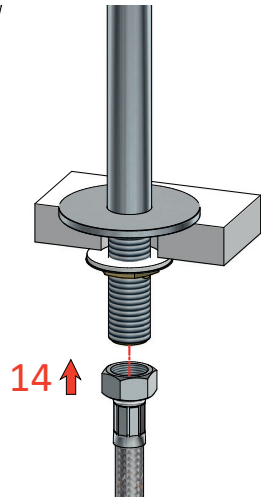

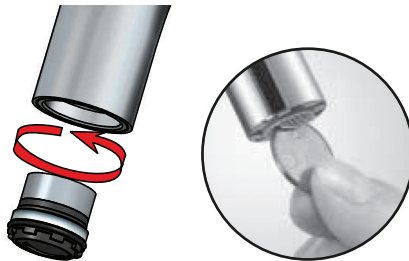
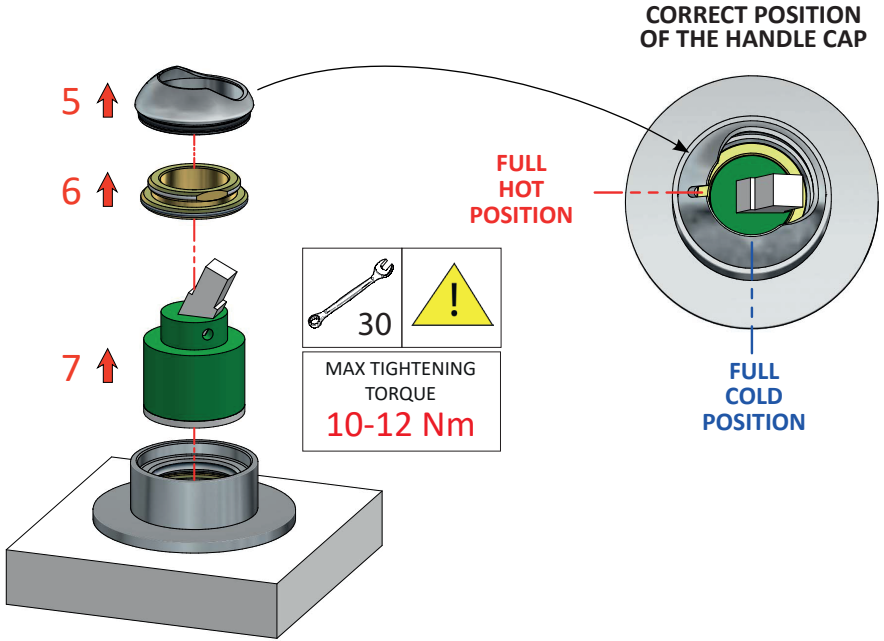
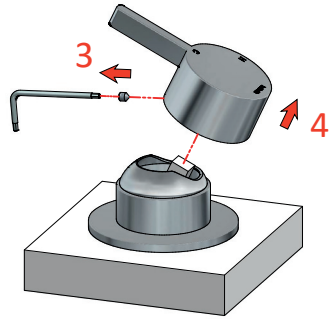
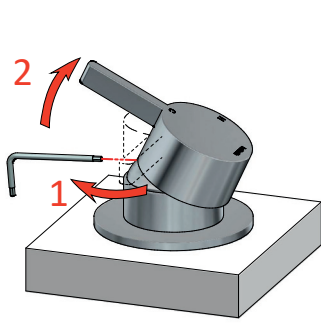

























4





CLEANING - PULIZIA - NETTOYAGE - REINIGUNG - LIMPIEZA - REINIGING

	✓			✗		WARNING	
CR CHROME	 WATER ✓	 LIQUID SOAP ✓	 SMOOTH CLOTH ✓	 ABRASIVE SPONGE ✗	 ACID/ABRASIVE DETERGENT ✗	Inoxidable electrolytic finish Finitura elettrolitica inossidabile Finition électrolytique inoxydable	Inoxidierbare elektrolytische Ausführung Acabado electrolítico inoxidable Inoxidable elektrolitische afwerking
GN BRUSHED NICKEL	 WATER ✓	 LIQUID SOAP ✓	 SMOOTH CLOTH ✓	 ABRASIVE SPONGE ✗	 ACID/ABRASIVE DETERGENT ✗	Inoxidable electrolytic finish Finitura elettrolitica inossidabile Finition électrolytique inoxydable	Inoxidierbare elektrolytische Ausführung Acabado electrolítico inoxidable Inoxidable elektrolitische afwerking
BBP BRUSHED BRASS PVD	 WATER ✓	 LIQUID SOAP ✓	 SMOOTH CLOTH ✓	 ABRASIVE SPONGE ✗	 ACID/ABRASIVE DETERGENT ✗	Inoxidable PVD finish Finitura PVD inossidabile Finition PVD inoxydable	Inoxidierbare PVD Ausführung Acabado PVD inoxidable Inoxidable PVD afwerking
BCP BRUSHED COPPER PVD	 WATER ✓	 LIQUID SOAP ✓	 SMOOTH CLOTH ✓	 ABRASIVE SPONGE ✗	 ACID/ABRASIVE DETERGENT ✗	Inoxidable PVD finish Finitura PVD inossidabile Finition PVD inoxydable	Inoxidierbare PVD Ausführung Acabado PVD inoxidable Inoxidable PVD afwerking
MBP MATT BLACK PVD	 WATER ✓	 LIQUID SOAP ✓	 SMOOTH CLOTH ✓	 ABRASIVE SPONGE ✗	 ACID/ABRASIVE DETERGENT ✗	Inoxidable PVD finish Finitura PVD inossidabile Finition PVD inoxydable	Inoxidierbare PVD Ausführung Acabado PVD inoxidable Inoxidable PVD afwerking
PBP POLISHED BLACK PVD	 WATER ✓	 LIQUID SOAP ✓	 SMOOTH CLOTH ✓	 ABRASIVE SPONGE ✗	 ACID/ABRASIVE DETERGENT ✗	Inoxidable PVD finish Finitura PVD inossidabile Finition PVD inoxydable	Inoxidierbare PVD Ausführung Acabado PVD inoxidable Inoxidable PVD afwerking

TERMS OF SALE AND WARRANTY
CONDIZIONI DI VENDITA E GARANZIA
CONDITIONS DE VENTE ET GARANTIE
CONDICIONES DE VENTA Y GARANTÍA
VERKAUFSBEDINGUNGEN UND GARANTIE
VERKOOP- EN GARANTIEVOORWAARDEN

NETHERLANDS
BELGIUM
LUXEMBOURG
UK AND IRELAND

ALL COUNTRIES
(EXCEPT BENELUX, UK AND IRELAND)

<https://www.hotbath.nl/garantie>

<https://hotbath.it/en/termsofsale>



Hotbath B.V.
Nieuwland Parc 210
2952 DC Alblasserdam
Nederland
E info@hotbath.nl
W hotbath.nl



Hotbath Srl
Via Marco Polo 135/D
I-55049 Viareggio
Italy
E info@hotbath.it
W hotbath.it

hotbath
italian bathroomware