

GROHE

WATER TECHNOLOGY

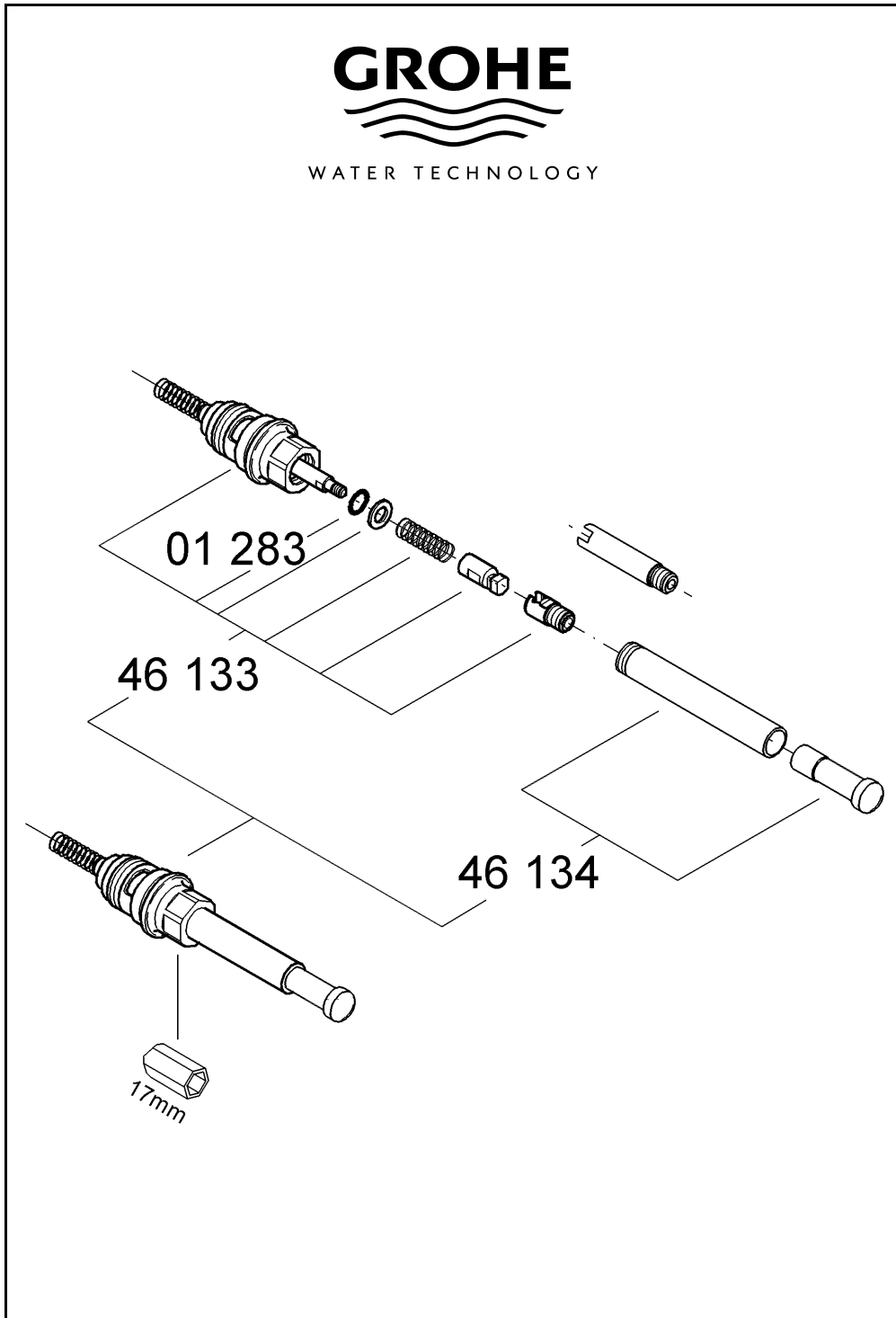

95.228.131/ÄM 90 750/02.01