

Montage Handleiding Serie ST04150

Hoekcabine Serie-ST04150

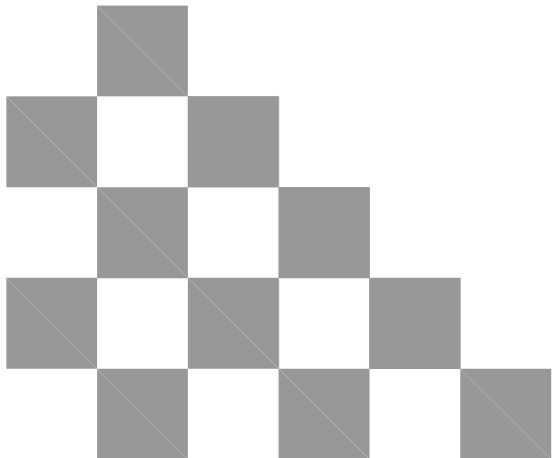

VAN RIJN PRODUCTS



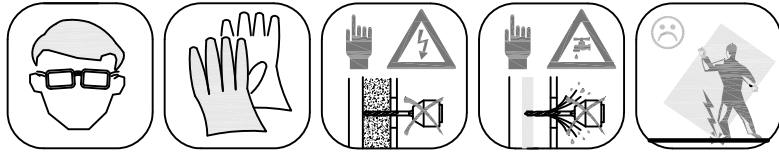

Wij danken u voor uw keuze voor één van onze doucheopstellingen en we wensen u veel plezier met uw aankoop. Lees de instructies aandachtig door voordat u begint met de montage. Niet juist naleven van de instructies kan de garantie doen vervallen.

BELANGRIJKE MEDEDELING

Controleer de inhoud van de verpakking op eventuele transportschade en kijk of alle onderdelen aanwezig zijn.

Zet het glas tijdens het uitpakken nooit direct op de grond, gebruik altijd karton of een vergelijkbaar materiaal als ondergrond. Wees voorzichtig bij het verplaatsten, let hierbij vooral op de hoeken en randen van het glas.

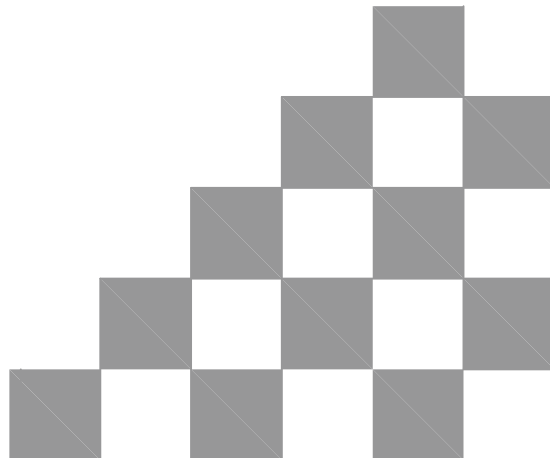

ST04150100

| | | | |
|---|---|--------------------------------------|--------------------------------------|
| <input type="checkbox"/> TIMELESS | <input type="checkbox"/> VOORZIJDE | <input type="checkbox"/> CLEARSHIELD | <input type="checkbox"/> VOORZIJDE |
| <input type="checkbox"/> SPIEGEL | <input type="checkbox"/> ACHTERZIJDE | | <input type="checkbox"/> ACHTERZIJDE |
| <input checked="" type="checkbox"/> HELDER GLAS | <input type="checkbox"/> VOORZIJDE | CE-keurmerk onder | |
| <input type="checkbox"/> SATIJN GLAS | <input type="checkbox"/> ACHTERZIJDE | | |
| <input type="checkbox"/> MIRASTAR GLAS | <input type="checkbox"/> SPIEGELZIJDE VOORZIJDE | | |
| <input type="checkbox"/> OPTI WHITE GLAS | <input type="checkbox"/> BEDRUKT VOORZIJDE | | |
| <input type="checkbox"/> CREPI GLAS | <input type="checkbox"/> VOORZIJDE | | |
| <input type="checkbox"/> GESTRAALD GLAS | <input type="checkbox"/> ACHTERZIJDE | | |
| <input type="checkbox"/> MASTERRAY | | | |
| <input type="checkbox"/> MASTERCARRE | | | |
| <input type="checkbox"/> MASTERPOINT | | | |
| <input type="checkbox"/> MASTERLIGNE | | | |
| <input type="checkbox"/> GRIJS ROOKGLAS | | | |
| <input type="checkbox"/> BRONS ROOKGLAS | | | |

Molendijk Noord 53 T: +31(0)548 – 515640
7461 PJ Rijssen info@vanrijnproducts.nl

| | | | |
|--------------|-------------|----------------------------|-----------------|
| Aantal: 1 | Leverdatum: | Ordernummer: ST04150100 | Getekend: MZ |
|--------------|-------------|----------------------------|-----------------|

ST0415090

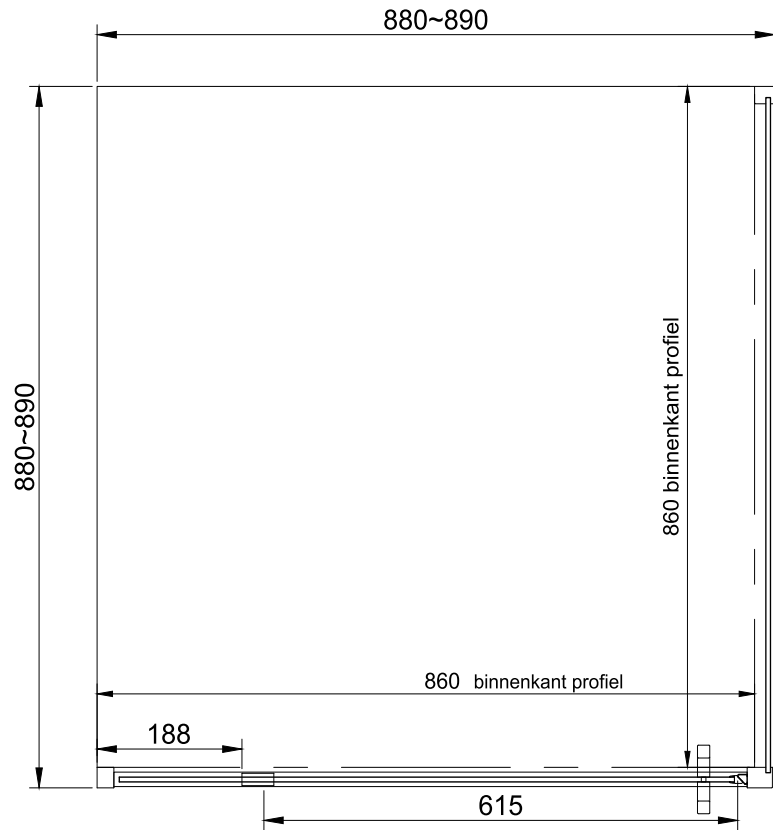

- TIMELESS
- SPIEGEL
- HELDER GLAS
- SATIEN GLAS
- MIRASTAR GLAS
- OPTI WHITE GLAS
- CREPI GLAS
- GESTRAALD GLAS
- MASTERRAY
- MASTERCARRE
- MASTERPOINT
- MASTERLIGNE
- GRIJS ROOKGLAS
- BRONS ROOKGLAS

- VOORZIJDE
- ACHTERZIJDE

- CLEARSHIELD
- VOORZIJDE
- ACHTERZIJDE



CE-keurmerk onder

Molendijk Noord 53 T: +31(0)548 - 515640
7461 PJ Rijssen info@vanrijnproducts.nl

| | | | |
|---------|-------------|--------------|-----------|
| Aantal: | Leverdatum: | Ordernummer: | Getekend: |
| 1 | | ST0415090 | MZ |

- Check BESLAGTYPE
- Check GLASTYPE
- Check GLASMAAT
- Check SCHUINING / SPARING

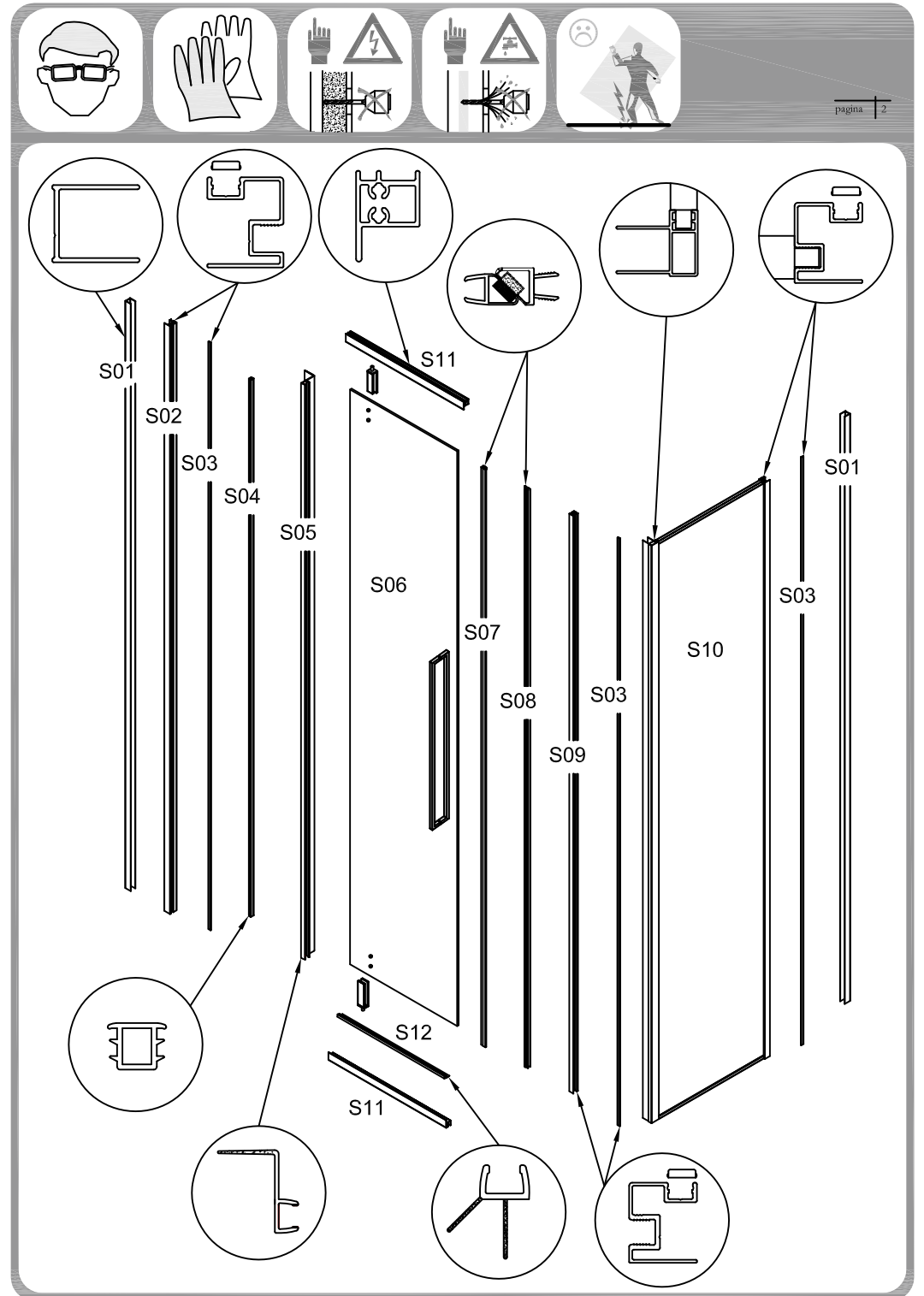

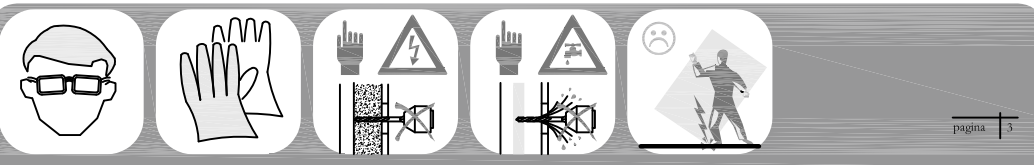

| | | | | |
|---------------|---------------|---------------|---------------|-------------------|
| S13 2x | S14 1x | S15 2x | S16 2x | S17 L R 1x |
| S18 6x | S19 8x | S20 9x | S21 6x | S22 1x |
| S23 1x | | | | |
| | | | | |
| | | | | |

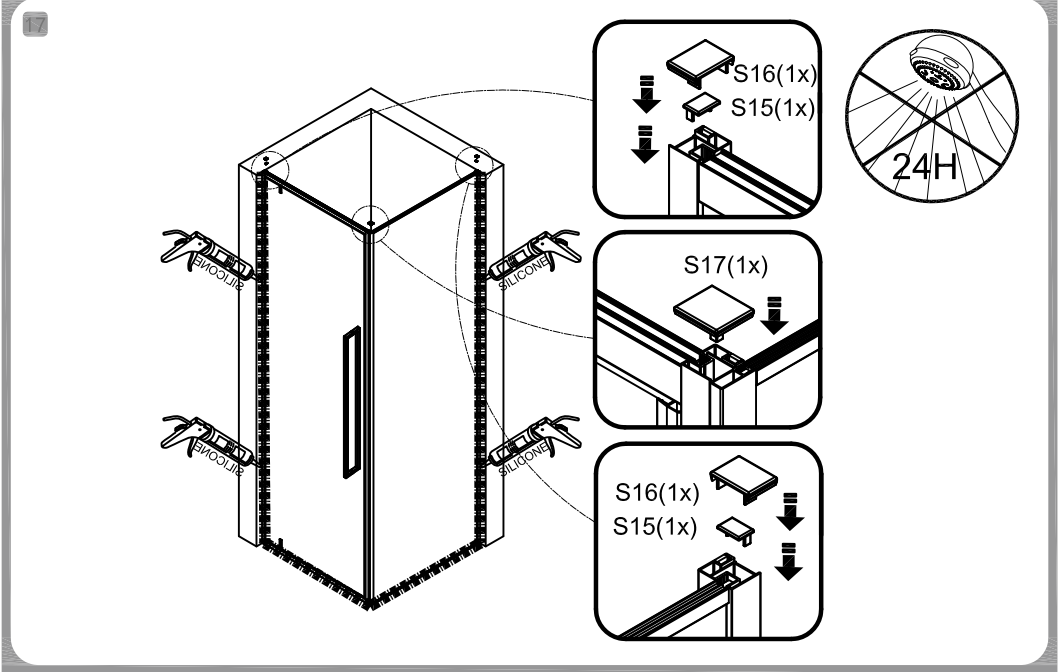
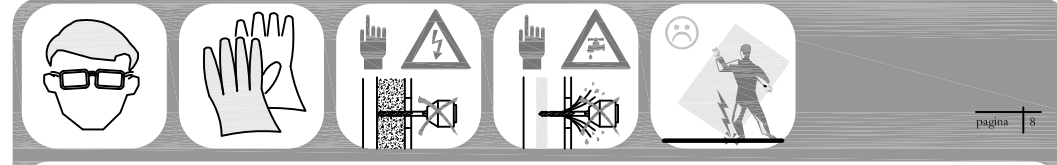
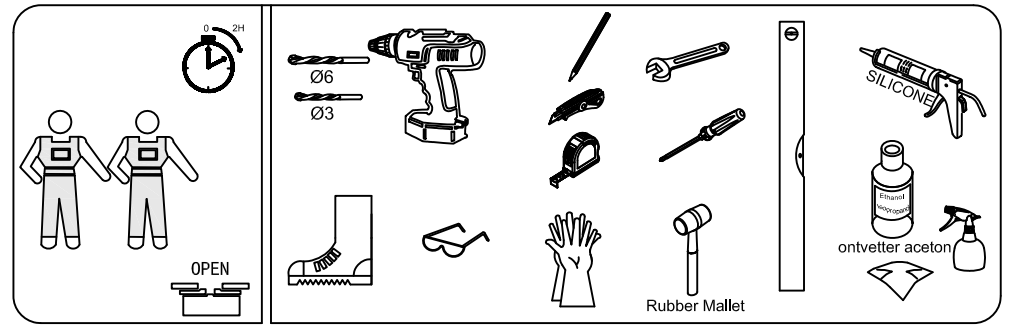

INSTRUCTIE VOOR GOED GEBRUIK EN ONDERHOUD

De douchewand moet na elk gebruik schoon gemaakt worden. Gebruik hierbij geen chemische middelen, maar een zachte doek of wisser. Gebruik nooit schuurmiddelen.

