

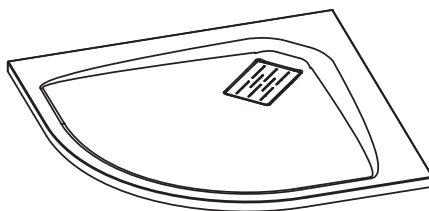

- F Notice de montage ● GB Installation instructions
- E Manual de instalación ● I Istruzioni di montaggio
- NL Montage instructies ● D Montageanleitung

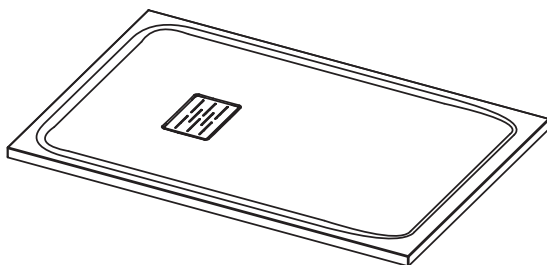

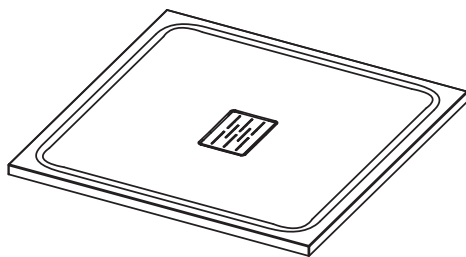

- F Attention aux étapes :
- GB Check installation steps :
- E Atención a los pasos :
- I Attenzione ai passi :
- NL Aandacht voor de stappen :
- D Achtung vor den Schritten :

P. 7 - 32 - 33

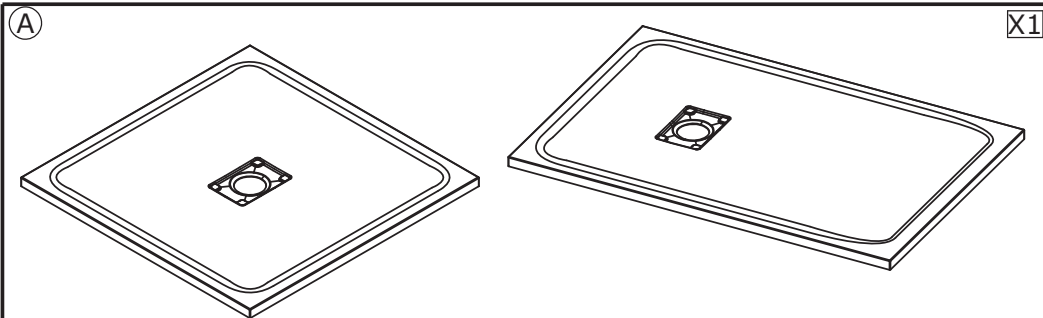

70X70	75X75	80X80	90X70	90X90	100X70	100X80	100X90	100X100
100X70	110X80	120X70	120X80	120X90	120X100	130X70	130X80	140X70
140X80	140X90	140X100	150X70	150X80	150X90	150X100	160X70	160X80
160X90	160X100	170X70	170X80	170X90	180X80	180X90	180X100	190X90
200X100								

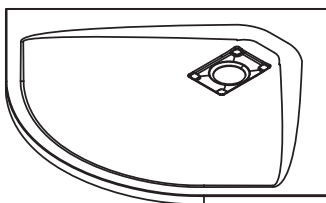

80X80	90X90							
-------	-------	--	--	--	--	--	--	--

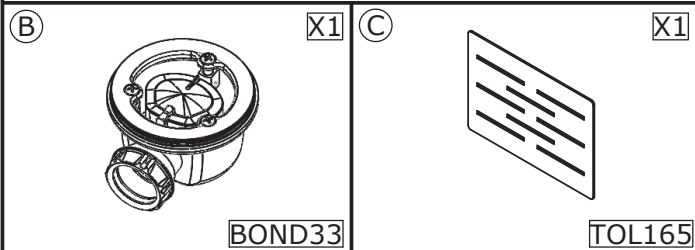

- Les quantités données sont les quantités utiles au montage. les sachets fournis contiennent des pièces supplémentaires.
- The quantities given are what are required for the installation. There may be some surplus in the package provide.
- Las cantidades indicadas son las cantidades necesarias para el montaje. Las bolsitas incluidas contienen piezas suplementarias.
- Le quantità fornite sono le quantità necessarie al montaggio. I sacchetti forniti contengono pezzi supplementari.
- De aangegeven aantallen zijn bestemd voor de montage. De bijgeleverde zakjes bevatten extra onderdelen
- Die Mengenangaben beziehen sich auf die für die Montage benötigten Teile. Es kann eine gewisse Überzahl an Teilen in der Packung vorhanden sein.

**F** Matériel nécessaire **GB** Tools required **E** Material necesario  
**I** Materiale necessario **NL** Benodigdheden **D** Erforderliche Werkzeuge

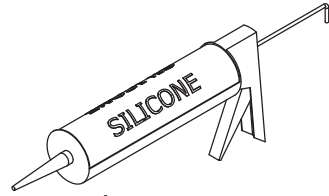
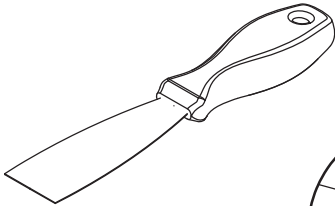
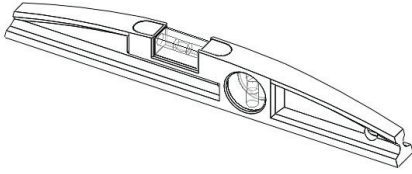

- F** Colle polyuréthane ou MS polymère
- GB** Polyurethane adhesive or MS polymer
- E** Pegamento poliuretano o polímero MS
- I** Colla poliuretantica o MS polimero
- NL** Polyurethaan of MS-polymeer lijm
- D** Polyurethan oder MS-Polymere Montagekleber verwenden

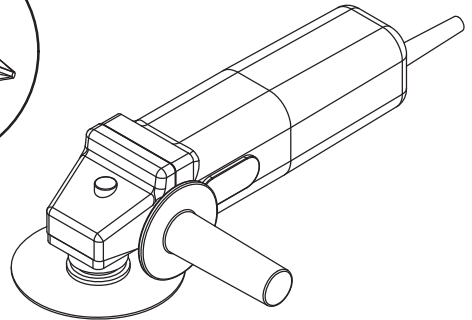
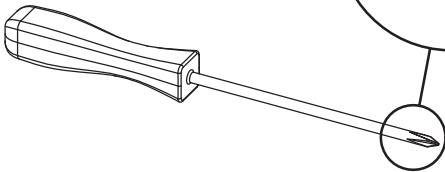

- F** Meuleuse avec lame diamant Ø230mm min.
- GB** Grinder with diamond blade Ø230mm min.
- E** Pulidora con disco diamantado Ø230mm min.
- I** Mola con lama diamantata Ø230mm min.
- NL** Diamantslijpschijf Ø230mm min.
- D** Winkelschleifer mit Diamanttrennscheibe Ø230mm min.

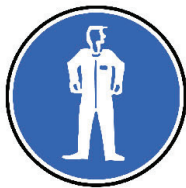

Ⓕ DECOUPE OPTIONNELLE DU RECEVEUR ⒼⒻ ZONE AVAILABLE FOR OPTIONAL RECUTTING

Ⓔ RECORTE OPCIONAL ⒼⒹ TAGLIO OPZIONALE DEL PIATTO

ⒼⒻ ZAGEN VAN DE DOUCHEBAK, OPTINEEL

ⒼⒹ OPTIONALE SCHNEIDBEREICHE DER DUSCHWANNE

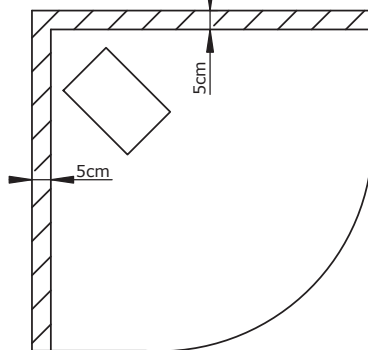
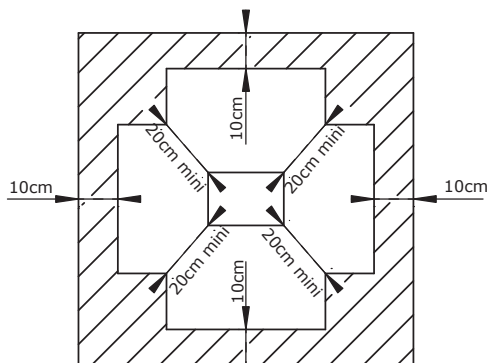
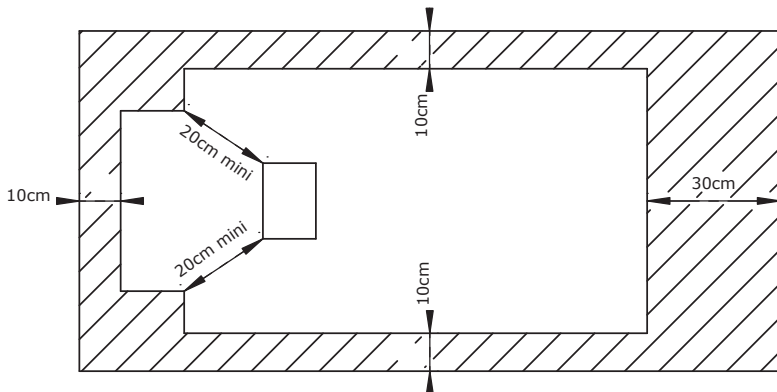

- Ⓕ Zone MAXI découpable
- ⒼⒹ MAX cuttable area
- Ⓔ Zone MAXIMA de recorte
- ⒼⒹ Limite MASSIMO di taglio
- ⒼⒻ MAXIMAAL aanpasbaar deel
- ⒼⒹ MAXIMALER Schneidbereich

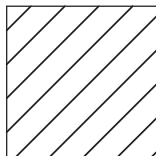

1

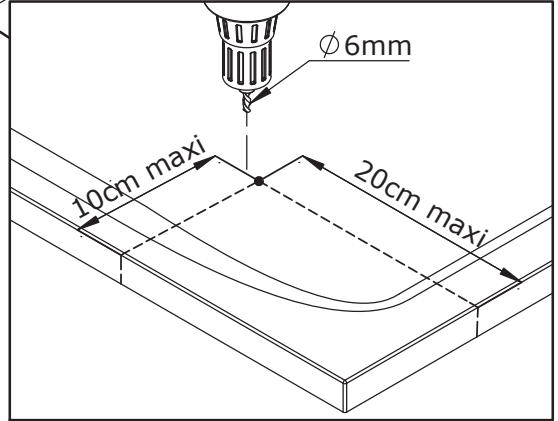
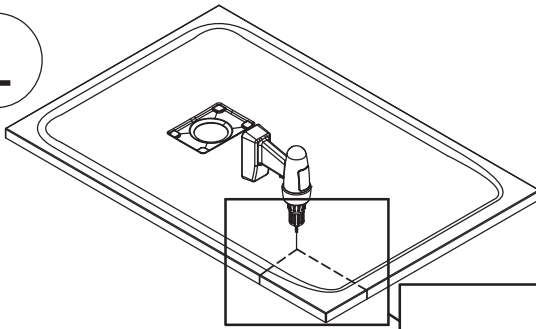

2

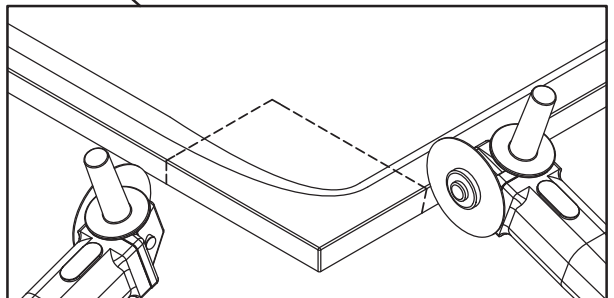
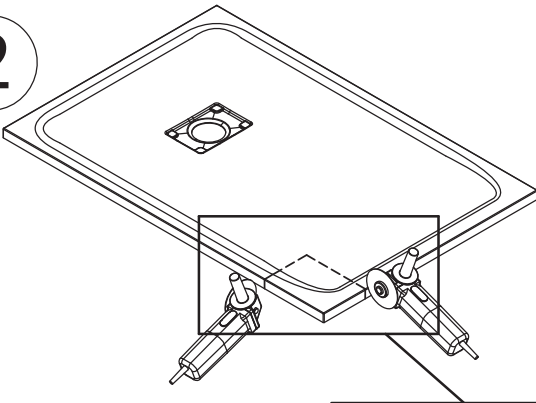

3



Ⓕ - Appliquer une couche de colle polyuréthane ou MS polymère à l'aide d'une spatule sur la surface coupée et combler l'espace entre les nervures du receveur avec une couche de mortier adhésif.

ⒼⒷ - Apply a polyurethan adhesive or MS polymer layer using a spatula over the raw surface and fill the space between the ribs of the tray with a layer of adhesive mortar.

Ⓔ - Aplicar una capa de pegamento poliuretano o polímero MS en la superficie recortada. Puede ayudarse de una espátula y rellenar los espacios huecos del plato con una capa de mortero adhesivo.

Ⓘ - Applicare della colla poliuretanică o MS polimerico con l'aiuto di una spatola sulla parte tagliato e compensare lo spazio tra le venature del piatto con uno strato di materiale adesivo.

ⓃⓁ - Breng met een spatel een laag polyurethaan lijm of MS polymeer lijm aan op de zaagranden, en vul de tussenliggende ruimte tot het steunoppervlak van de douchebak op met een laag cement.

Ⓓ - Wenn Sie ihre Duschtasse zuschneiden, müssen die Schnittkanten mittels Polyurethan- oder MS-Polymer-Klebstoff versiegelt werden. Tragen Sie die Versiegelung mit einem Spachtel auf der Schnittfläche bis unterhalb der Duschtasse auf.

Ⓕ Colle polyuréthane/MS polymère

ⒼⒷ Polyurethane adhesive/MS polymer

Ⓔ Pegamento poliuretano/polímero MS

Ⓘ Colla poliuretanică/MS polimerico

ⓃⓁ Polyurethaan/MS polymeer lijm

Ⓓ Schicht aus Polyurethan-/MS-Polymer-Klebstoff

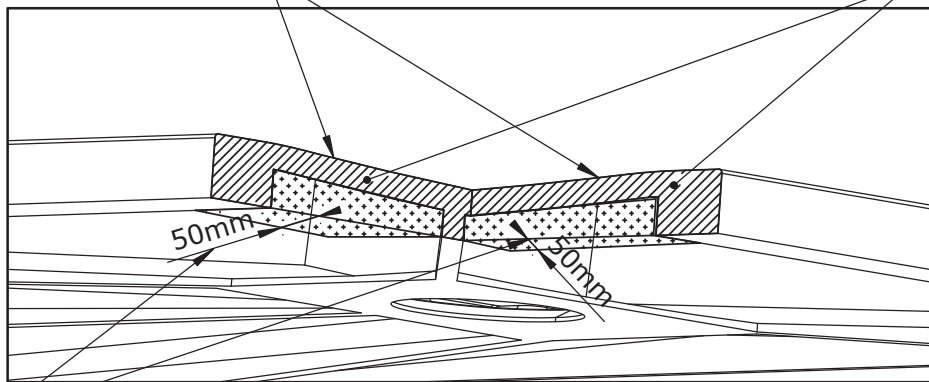
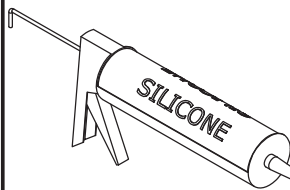

Ⓕ Couche de 50mm de mortier adhésif ⒼⒷ 50mm layer of adhesive mortar

Ⓔ Capa de 50mm de grosor de mortero adhesivo

Ⓘ Strato di 50mm di materiale adesivo

ⓃⓁ Laag van 50mm lijm mortel Ⓓ 50 mm Versiegelung auftragen

● Nombre de pieds ● Feet quantity ● Cantidad de pies

● Quantità di piedini ● Hoeveelheid voeten ● Anzahl an FüÙe



70X70	4	75X75	4	80X80	4	90X70	5	90X90	4	100X70	5	100X80	5	100X90	5	100X100	6
100X70	6	110X80	6	120X70	7	120X80	7	120X90	7	120X100	7	130X70	6	130X80	6	140X70	8
140X80	10	140X90	10	140X100	10	150X70	8	150X80	10	150X90	10	150X100	10	160X70	10	160X80	10
160X90	10	160X100	10	170X70	10	170X80	10	170X90	10	180X80	10	180X90	10	180X100	10	190X90	11
200X100	11																



80X80	5	90X90	7
-------	---	-------	---

● La distance bord à bord entre deux pieds ne doit pas être de plus de 30 cm.  
LES PIEDS DOIVENT ETRE INSTALLES SUR LES NERVURES DU RECEVEUR.

● The distance from the edge of the shower tray to the edge of a peripheral support should be no more than 30 cm.  
THE FEET MUST BE INSTALLED ON THE SHOWER TRAY RIBS.

● La distancia entre cada pie no debe superar los 30 cm.  
LOS PIES DEBEN ESTAR INSTALADOS SIGUIENDO LAS NERVIOS DEL PLATO.

● La distanza tra due piedi non dovrebbe essere superiore a 30 cm.  
I PIEDI DEVONO ESSERE INSTALLATI SULLE NERVATURE DEL PIATTO DOCCIA.

● De afstand tussen twee stelpoten mag niet meer dan 30 cm bedragen.  
DE STELPOTEN DIENEN OP HET STEUNOPPERVLAK VAN DE DOUCHEBAK GEÏNSTALLEERD TE WORDEN.

● Der Abstand zwischen zwei verstellbaren FüÙen darf 30 cm nicht überschreiten.  
DIE FÜÙE MÜSSEN AUF DEN TRÄGERN DER DUSCHTASSE MONTIERT WERDEN.

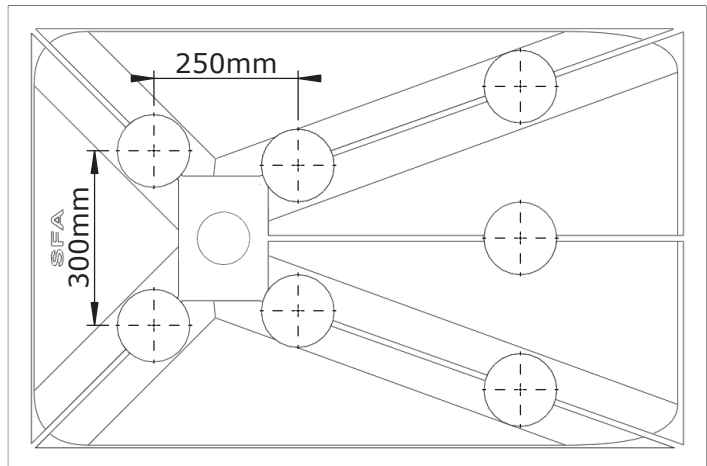

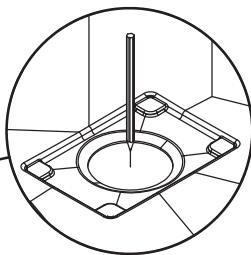
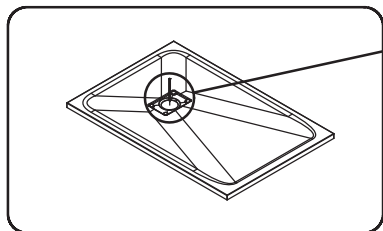
**F**

Tracer la position de la bonde et réaliser un montage à blanc de la bonde et du receveur

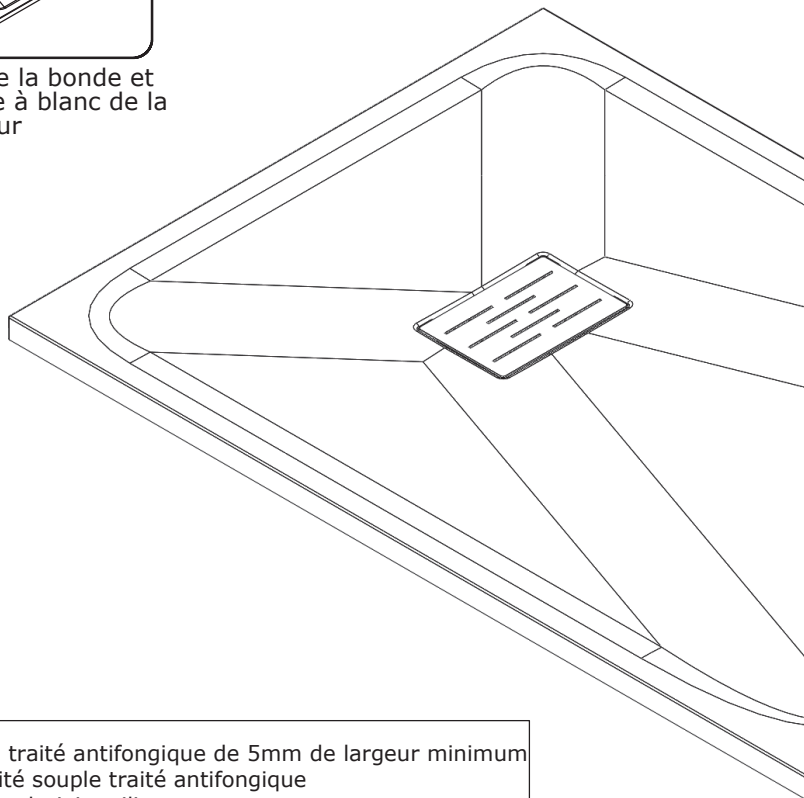

- ① - silicone de finition traité antifongique de 5mm de largeur minimum
- ② - silicone d'étanchéité souple traité antifongique
- ③ - élément de soutien du joint silicone
- ④ - silicone d'appui
- ⑤ - colle polyuréthane ou MS polymère

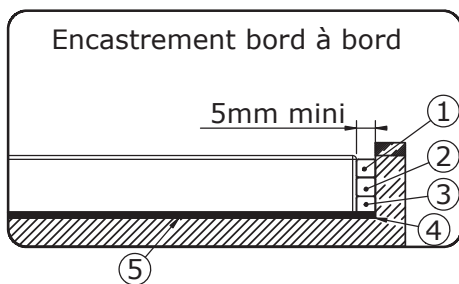
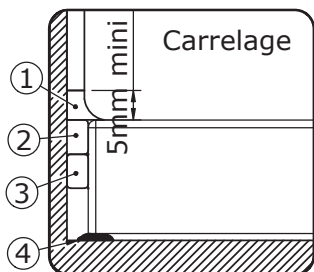



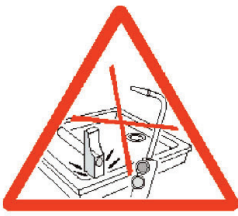

Pendant toute la durée des travaux, protéger le receveur contre toute agression : brûlures, chocs, rayures, décapants...



Le montage d'une soupape anti-vide est nécessaire pour une utilisation optimale si un autre appareil sanitaire est raccordé sur la même évacuation.

Ne pas utiliser d'acide chlorhydrique ni de dégraissant puissant

Pose directe au sol

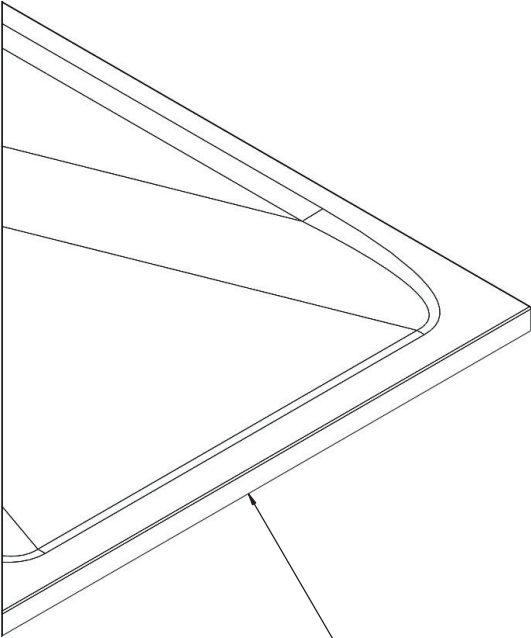
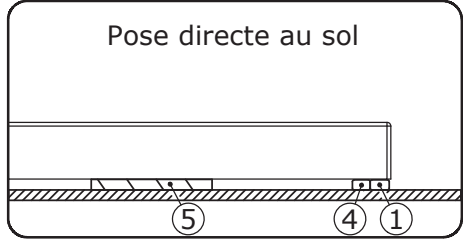

Sol rigide indispensable

En butée contre le carrelage

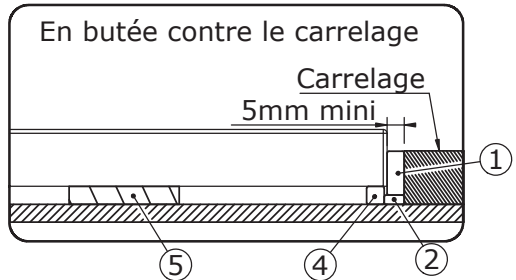

# TYPES D'INSTALLATION KINEROCK EVO

## KINEROCK EVO CARRÉ ET RECTANGULAIRE

### 1. Posé sur pieds réglables avec habillage carré

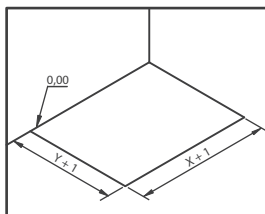
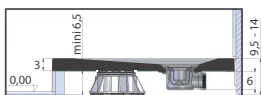
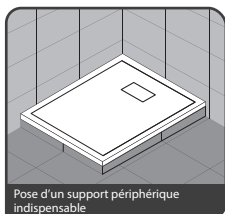

Préparation de l'implantation



X	Y	B	C	D
80	80	25	-	5,5
90	90	35	-	15,5
70	70		22,5	22,5
75	75		25	25
80	80		27,5	27,5
90	90		32,5	32,5
100	100		37,5	37,5
90	70		22,5	19,5
100	70		22,5	19,5
100	80		27,5	24,5
100	90		32,5	29,5
110	70		22,5	19,5
110	80		27,5	24,5
120	70		22,5	24,5
120	80		27,5	24,5
120	90		32,5	29,5
120	100		37,5	29,5
130	70		22,5	19,5
130	80		27,5	24,5
140	70		22,5	19,5
140	80		27,5	24,5
140	90		32,5	29,5
140	100		37,5	29,5
150	70		22,5	19,5
150	80		27,5	24,5
150	90		32,5	29,5
160	70		22,5	19,5
160	80		27,5	24,5
160	90		32,5	29,5
160	100		37,5	29,5
170	70		22,5	19,5
170	80		27,5	24,5
170	90		32,5	24,5
180	80		27,5	24,5
180	90		32,5	29,5
180	100		37,5	29,5
190	90		32,5	29,5
200	100		37,5	19,5

### 2. Posé en butée contre le carrelage

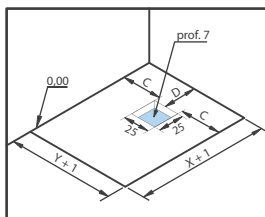
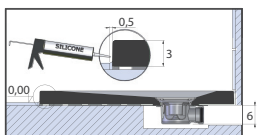
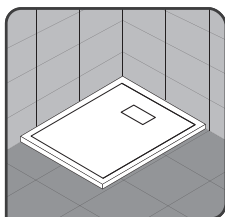

Préparation de l'implantation

### 3. Encadré et posé sur pieds réglables

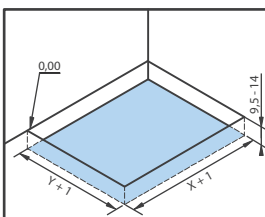
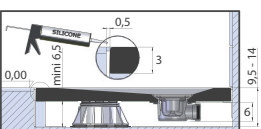
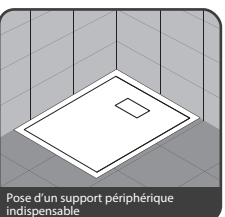

Préparation de l'implantation

### 4. Encadré et posé sans pieds réglables

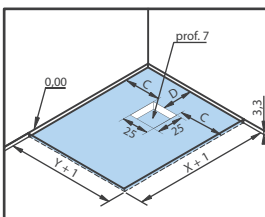
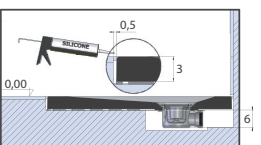
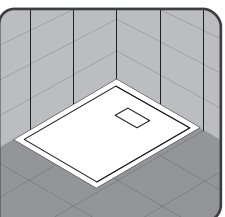

Préparation de l'implantation

# TYPES D'INSTALLATION KINEROCK EVO

## KINEROCK EVO 1/4 DE ROND

### 1. Posé sur pieds réglables avec habillage carrelé

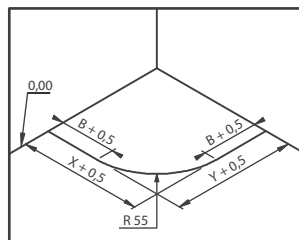
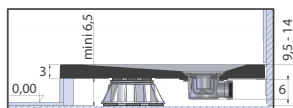

Préparation de l'implantation

### 2. Posé en butée contre le carrelage

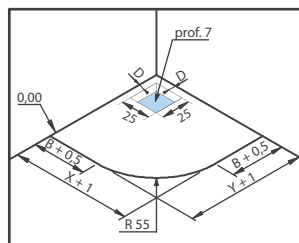
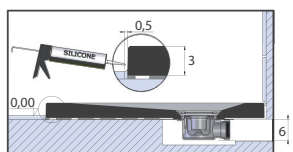
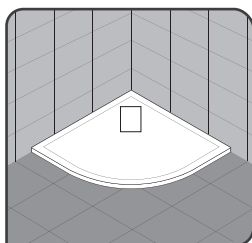

Préparation de l'implantation

### 3. Encastré et posé sur pieds réglables

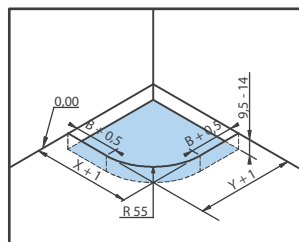
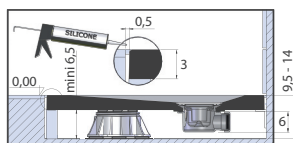
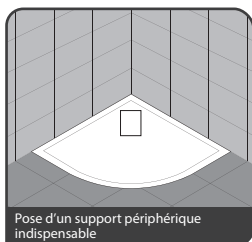

Préparation de l'implantation

### 4. Encastré et posé sans pieds réglables

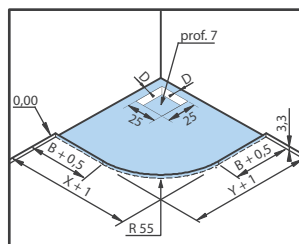
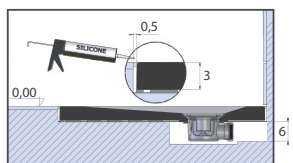
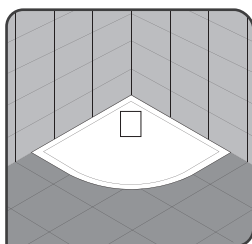

Préparation de l'implantation

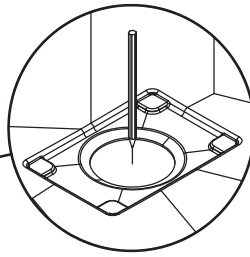
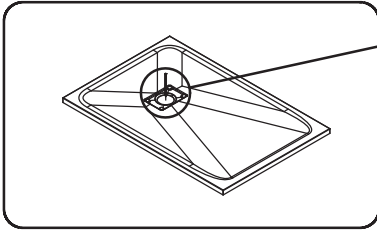

Mark the position of the waste and test-assemble the tray and waste

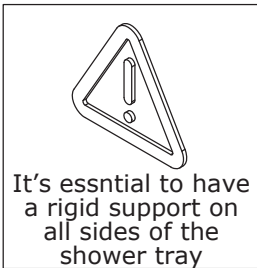
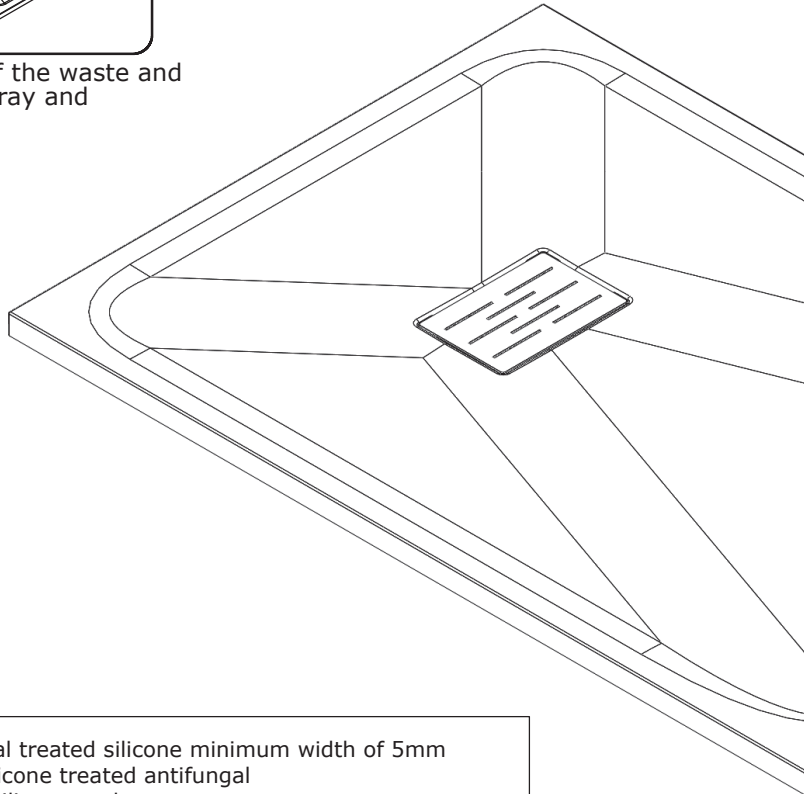

- ① - finishing antifungal treated silicone minimum width of 5mm
- ② - flexible sealing silicone treated antifungal
- ③ - support Element silicone seal
- ④ - silicone support
- ⑤ - polyurethane adhesive or MS polymer

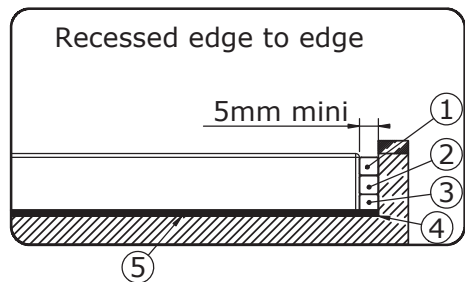
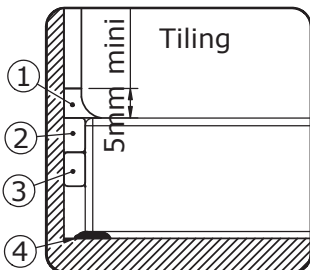



Throughout the protect the tray of the work, protect the recipient against any aggression: burns, shock, scratches, strppers...



Mounting a vacuum relief valve is required for use optimal if another fixture is connected to the same drain.

Do not use hydrochloric acid or powerful degreaser

### Direct floor installation

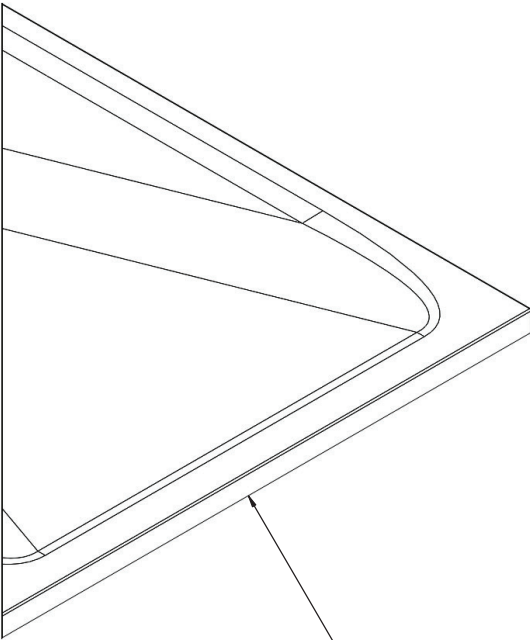
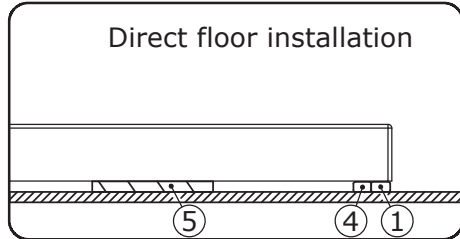

The base must be rigid, flat and dry

### Abutting against the tile

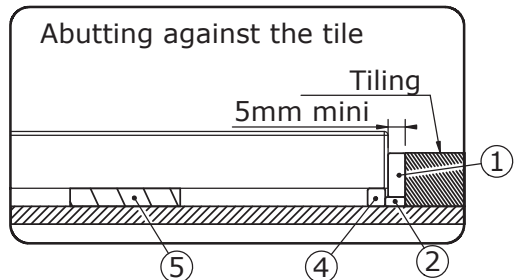

# INSTALLATION TYPES KINEROCK EVO

## KINEROCK EVO SQUARE AND RECTANGULAR

### 1. Mounted on adjustable legs with tiled cladding

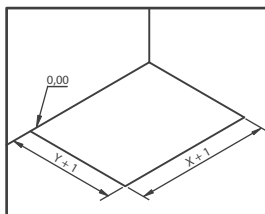
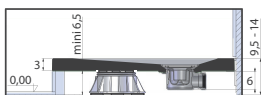

Pre-installation



X	Y	B	C	D
80	80	25	-	5,5
90	90	35	-	15,5
70	70		22,5	22,5
75	75		25	25
80	80		27,5	27,5
90	90		32,5	32,5
100	100		37,5	37,5
90	70		22,5	19,5
100	70		22,5	19,5
100	80		27,5	24,5
100	90		32,5	29,5
110	70		22,5	19,5
110	80		27,5	24,5
120	70		22,5	24,5
120	80		27,5	24,5
120	90		32,5	29,5
120	100		37,5	29,5
130	70		22,5	19,5
130	80		27,5	24,5
140	70		22,5	19,5
140	80		27,5	24,5
140	90		32,5	29,5
140	100		37,5	29,5
150	70		22,5	19,5
150	80		27,5	24,5
150	90		32,5	29,5
160	70		22,5	19,5
160	80		27,5	24,5
160	90		32,5	29,5
160	100		37,5	29,5
170	70		22,5	19,5
170	80		27,5	24,5
170	90		32,5	24,5
180	80		27,5	24,5
180	90		32,5	29,5
180	100		37,5	29,5
190	90		32,5	29,5
200	100		37,5	19,5

### 2. Installed in abutment against the tile

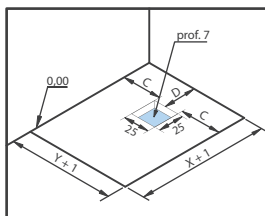
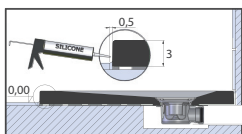
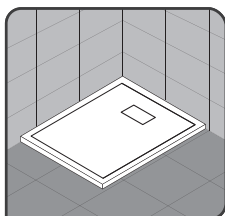

Pre-installation

### 3. Built-in and installed on adjustable feet

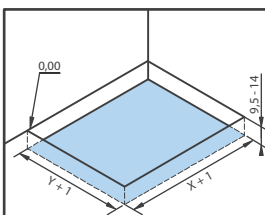
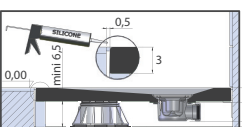
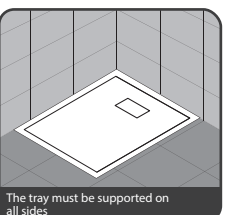

Pre-installation

### 4. Built-in and installed without adjustable feet

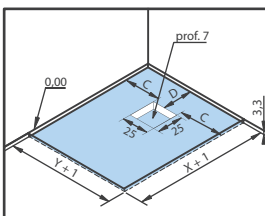
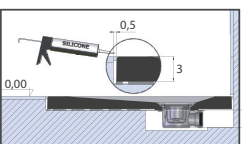
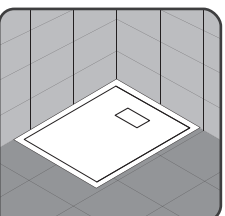

Pre-installation

# INSTALLATION TYPES KINEROCK EVO

## KINEROCK EVO 1/4 ROUND

### 1. Mounted on adjustable legs with tiled cladding

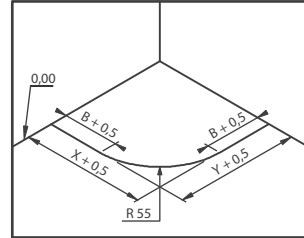
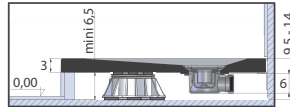

Pre-installation

### 2. Installed in abutment against the tile

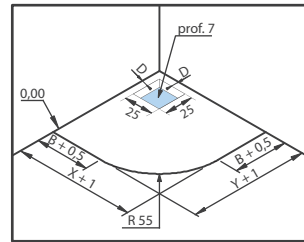
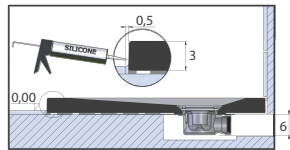
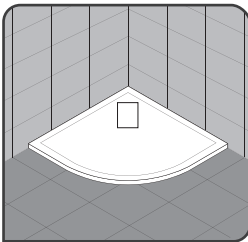

Pre-installation

### 3. Built-in and installed on adjustable feet

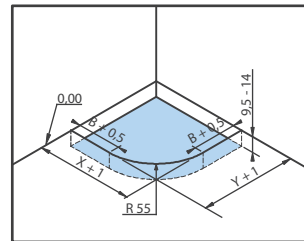
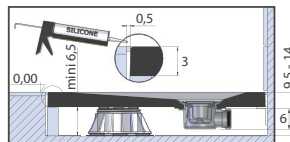

Pre-installation

### 4. Built-in and installed without adjustable feet

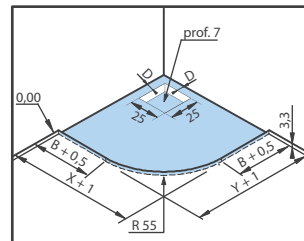
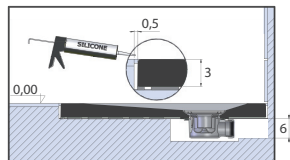
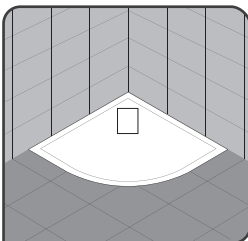

Pre-installation

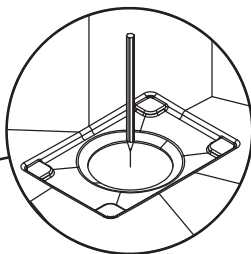
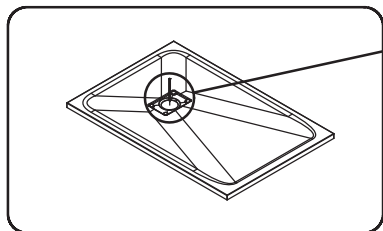
**E**

Marcar la ubicación del desagüe y montarlo con el plato para comprobar su correcta ubicación.

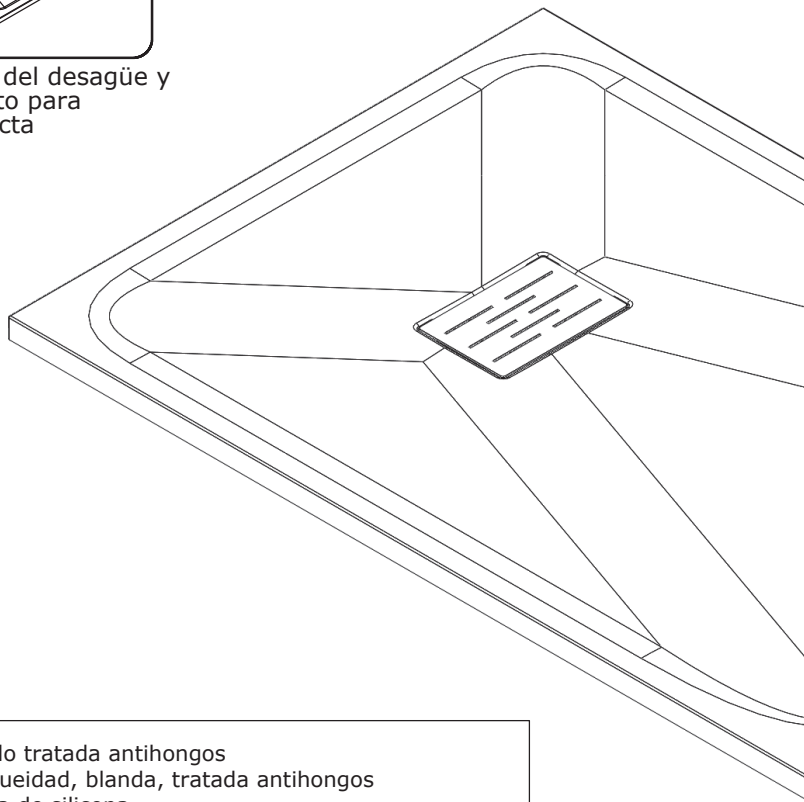

Es imprescindible instalar el plato en una zona que sea imputrescible en todos sus lados

- ① - silicona de acabado tratada antihongos
- ② - silicona de estanqueidad, blanda, tratada antihongos
- ③ - soporte de la junta de silicona
- ④ - silicona de apoyo
- ⑤ - pegamento poliuretano o polímero MS

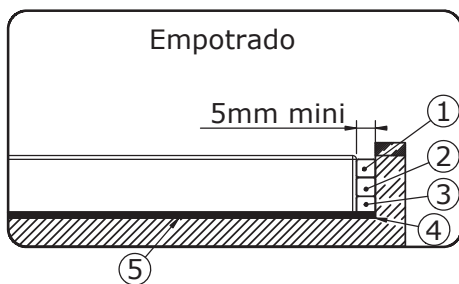
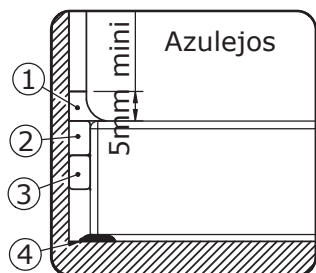





Durante las obras proteger el plato de golpes, quemaduras, rayaduras, etc...



La instalación de un venteo es necesaria si otro aparato está conectado al mismo recorrido de evacuación.

No utilizar ácido clorhídrico o desengrasante potente

Instalación directa al suelo

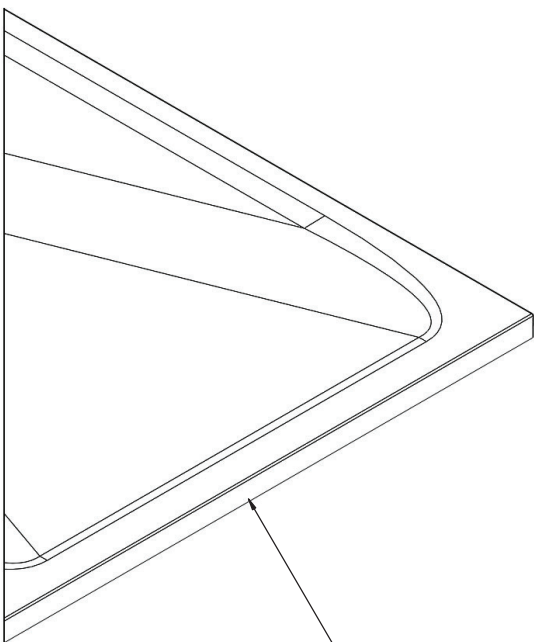
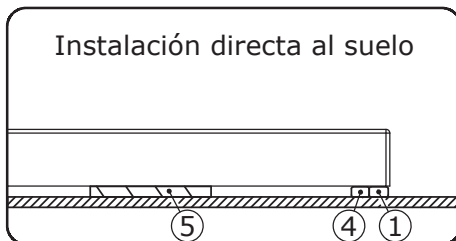

Suelo rígido, plano y seco indispensable

Instalación contra baldosas

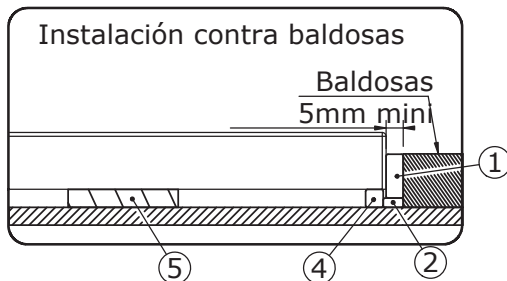

# TIPOS DE INSTALACIÓN KINEROCK EVO

## KINEROCK EVO CUADRADO Y RECTANGULARES

### 1. Instalado sobre pies regulables con revestimiento de baldosas

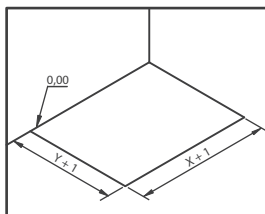
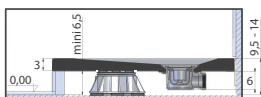

Preparación de la instalación



X	Y	B	C	D
80	80	25	-	5,5
90	90	35	-	15,5
70	70		22,5	22,5
75	75		25	25
80	80		27,5	27,5
90	90		32,5	32,5
100	100		37,5	37,5
90	70		22,5	19,5
100	70		22,5	19,5
100	80		27,5	24,5
100	90		32,5	29,5
110	70		22,5	19,5
110	80		27,5	24,5
120	70		22,5	24,5
120	80		27,5	24,5
120	90		32,5	29,5
120	100		37,5	29,5
130	70		22,5	19,5
130	80		27,5	24,5
140	70		22,5	19,5
140	80		27,5	24,5
140	90		32,5	29,5
140	100		37,5	29,5
150	70		22,5	19,5
150	80		27,5	24,5
150	90		32,5	29,5
160	70		22,5	19,5
160	80		27,5	24,5
160	90		32,5	29,5
160	100		37,5	29,5
170	70		22,5	19,5
170	80		27,5	24,5
170	90		32,5	24,5
180	80		27,5	24,5
180	90		32,5	29,5
180	100		37,5	29,5
190	90		32,5	29,5
200	100		37,5	19,5

### 2. Instalación directa al suelo

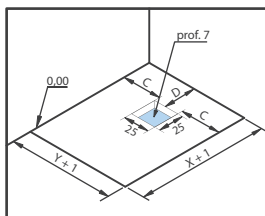
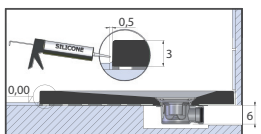
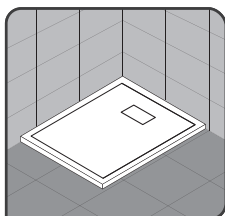

Preparación de la instalación

### 3. Instalación a ras de suelo, colocado sobre pies regulables

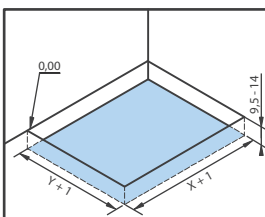
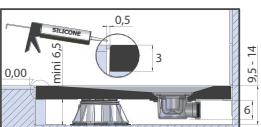

Preparación de la instalación

### 4. Instalación a ras de suelo, colocado sin pies regulables

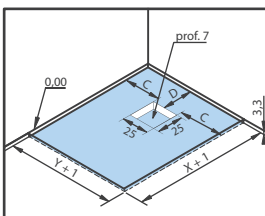
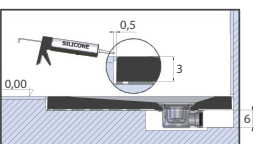
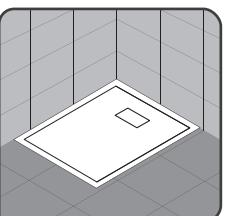

Preparación de la instalación

# TIPOS DE INSTALACIÓN KINEROCK EVO

## KINEROCK EVO ANGULAR

### 1. Instalado sobre pies regulables con revestimiento de baldosas

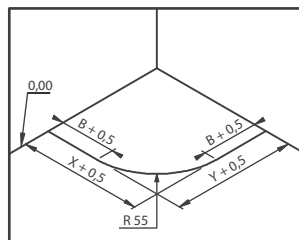
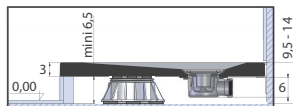

Preparación de la instalación

### 2. Instalación directa al suelo

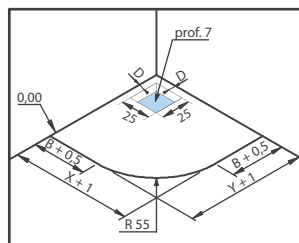
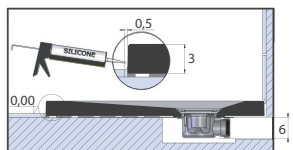
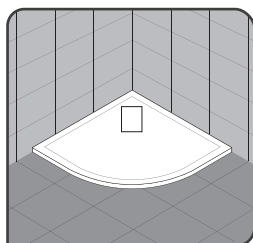

Preparación de la instalación

### 3. Instalación a ras de suelo, colocado sobre pies regulables

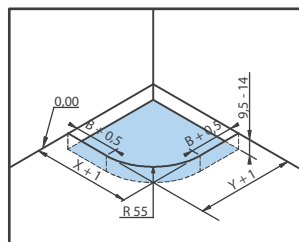
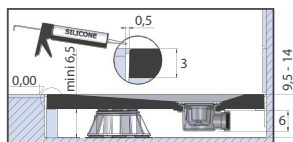

Preparación de la instalación

### 4. Instalación a ras de suelo, colocado sin pies regulables

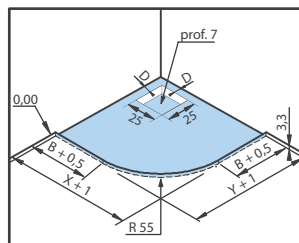
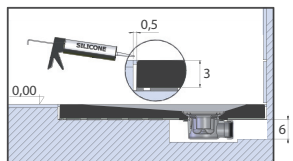
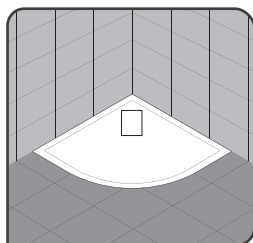

Preparación de la instalación

I

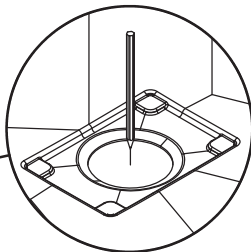
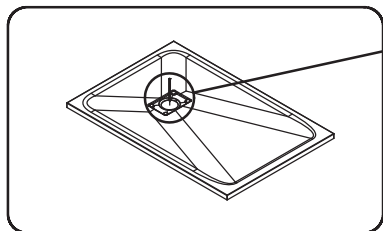

Tracciare la posizione dello scarico e realizzare un montaggio a vuoto dello scarico e del piatto

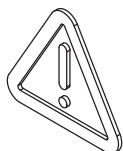
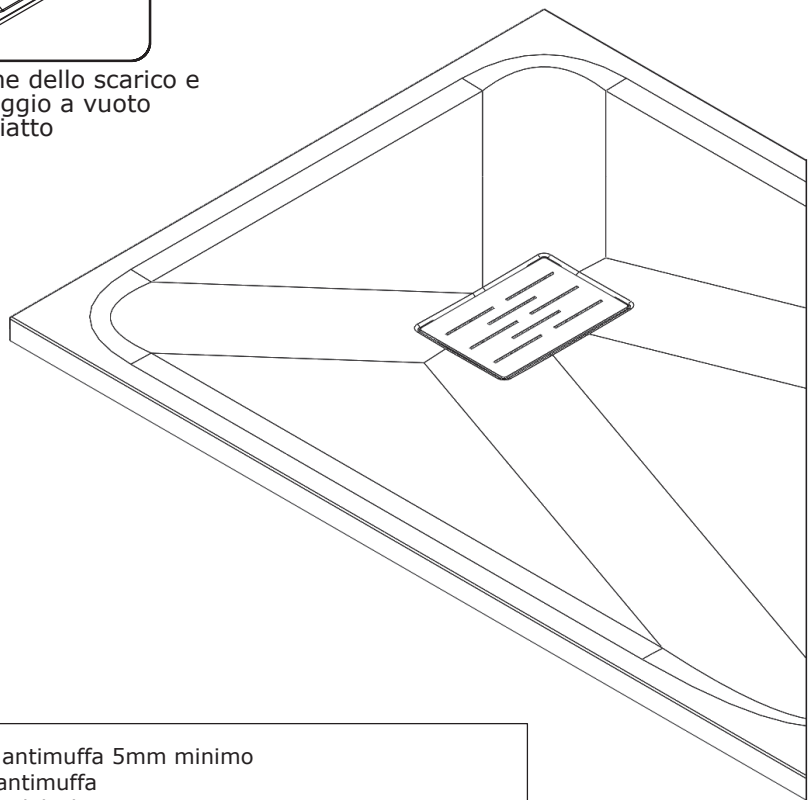

È essenziale avere un supporto inalterabile su tutti i lati del piatto

- ① - silicone di finitura antimuffa 5mm minimo
- ② - silicone di tenuta antimuffa
- ③ - elemento di tenuta del silicone
- ④ - supporte in silicone
- ⑤ - colla poliuretanica o MS polimero

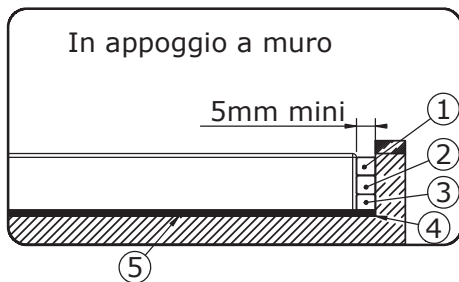
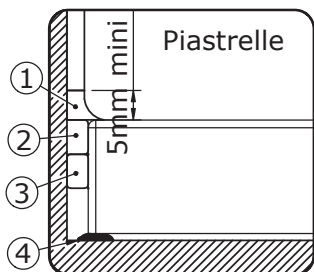



Durante la posa proteggere il piatto da graffi, colpi, attrezzi, bruciature ...



Il montaggio di una valvola di sicurezza è richiesto per un uso ottimale se un'altre utenze sono collegate allo stesso scarico.

Non utilizzare acido cloridrico o forti sgrassatori

Posa diretta al suolo

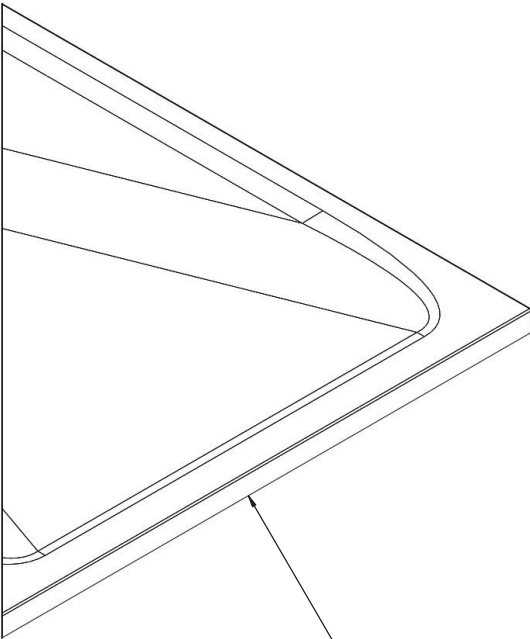
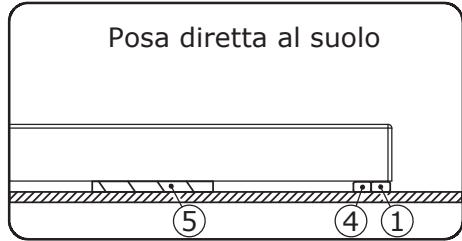

Suolo robusto e non umido

Battuta contro la piastrella

piastrella  
5mm mini

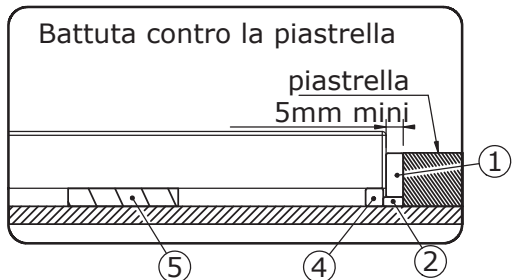

# TIPI DI INSTALLAZIONE DI KINEROCK EVO

## KINEROCK EVO QUADRATO E RETTANGOLARE

### 1. Montato su piedini regolabili con rivestimento in piastrelle

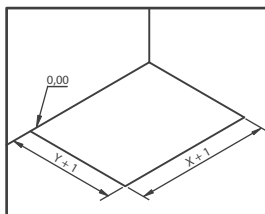
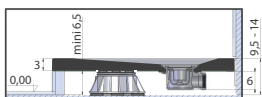

predisposizione impianto



X	Y	B	C	D
80	80	25	-	5,5
90	90	35	-	15,5
70	70		22,5	22,5
75	75		25	25
80	80		27,5	27,5
90	90		32,5	32,5
100	100		37,5	37,5
90	70		22,5	19,5
100	70		22,5	19,5
100	80		27,5	24,5
100	90		32,5	29,5
110	70		22,5	19,5
110	80		27,5	24,5
120	70		22,5	24,5
120	80		27,5	24,5
120	90		32,5	29,5
120	100		37,5	29,5
130	70		22,5	19,5
130	80		27,5	24,5
140	70		22,5	19,5
140	80		27,5	24,5
140	90		32,5	29,5
140	100		37,5	29,5
150	70		22,5	19,5
150	80		27,5	24,5
150	90		32,5	29,5
160	70		22,5	19,5
160	80		27,5	24,5
160	90		32,5	29,5
160	100		37,5	29,5
170	70		22,5	19,5
170	80		27,5	24,5
170	90		32,5	24,5
180	80		27,5	24,5
180	90		32,5	29,5
180	100		37,5	29,5
190	90		32,5	29,5
200	100		37,5	19,5

### 2. Installato in appoggio a pavimento

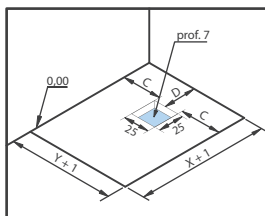
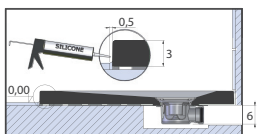
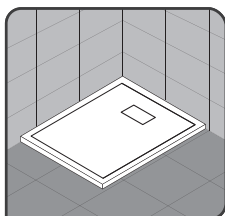

predisposizione impianto

### 3. Incassato e posizionato su piedini regolabili

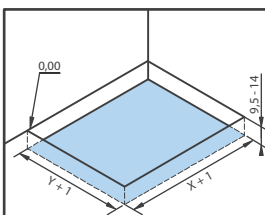
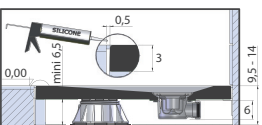

predisposizione impianto

### 4. Incassato e posizionato senza piedini regolabili

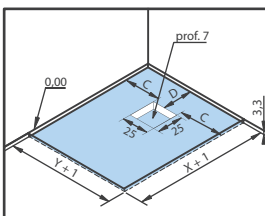
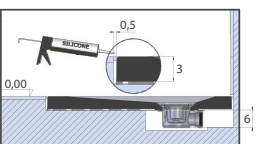
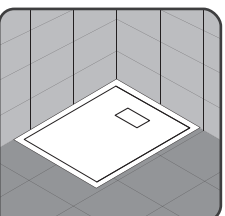

predisposizione impianto

# TIPI DI INSTALLAZIONE DI KINEROCK EVO

## KINEROCK EVO CURVO

### 1. Montato su piedini regolabili con rivestimento in piastrelle

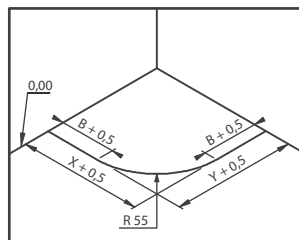
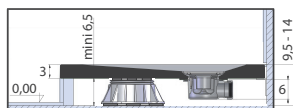

predisposizione impianto

### 2. Installato in appoggio a pavimento e

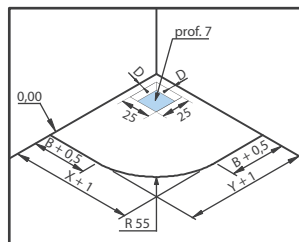
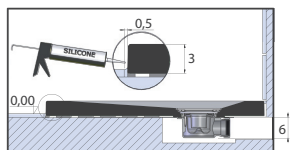
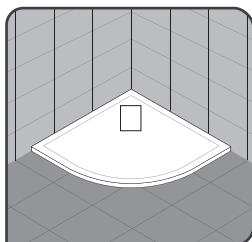

predisposizione impianto

### 3. Incassato e posizionato su piedini regolabili

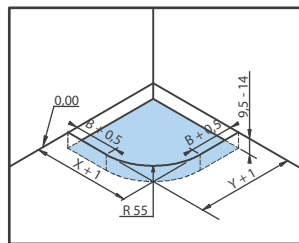
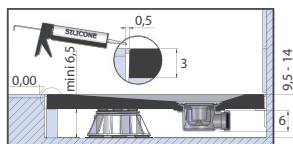

predisposizione impianto

### 4. Incassato e posizionato senza piedini regolabili

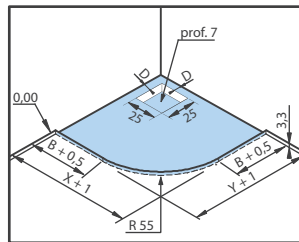
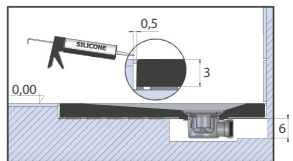
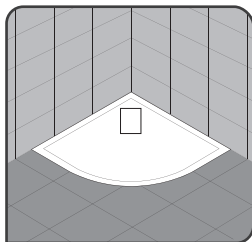

predisposizione impianto

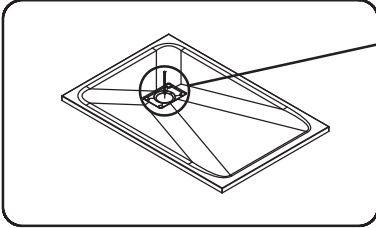

Markeer de positie van de afvoer en situeer de afvoer en de douchebak op de gewenste plaats

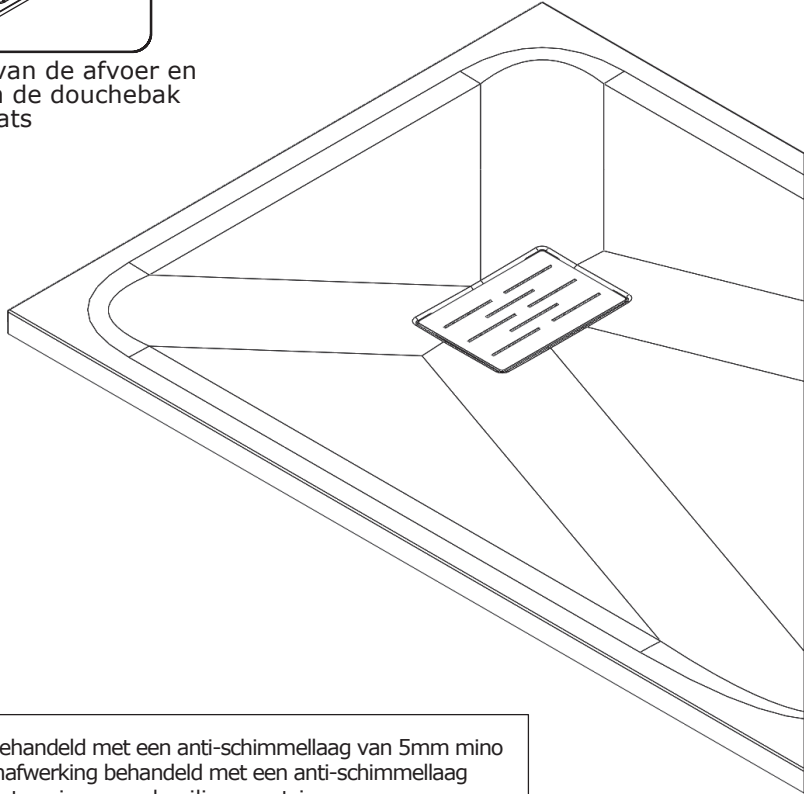

- ① - siliconenafwerking behandeld met een anti-schimmellaag van 5mm mino
- ② - waterdichte siliconenafwerking behandeld met een anti-schimmellaag
- ③ - element ter ondersteuning van de siliconenstrip
- ④ - aanbrengen van siliconenkit
- ⑤ - polyurethaan lijm of MS ployleer

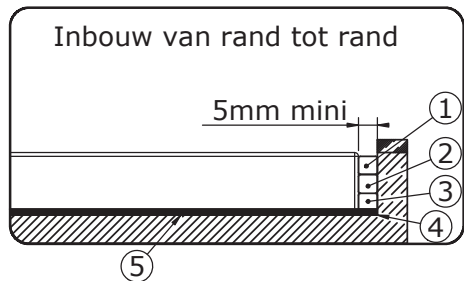
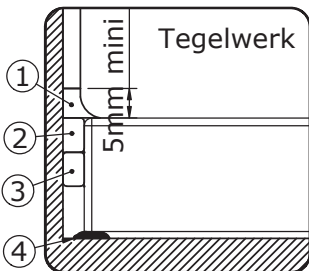



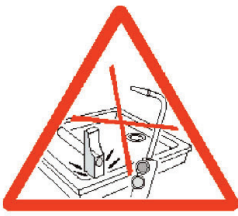

Bescherm de douchebak tijdens de werkzaamheden tegen brandplekken, schokken en beschadigingen door krassen etc...



De Montage van een afdichtingsklep/ventiel is noodzakelijk voor optimaal gebruik indien men een ander sanitair product wil aansluiten op dezelfde afvoer.

Geen chloorhoudende producten en ontvetters gebruiken!

Plaatsing direct op de vloer

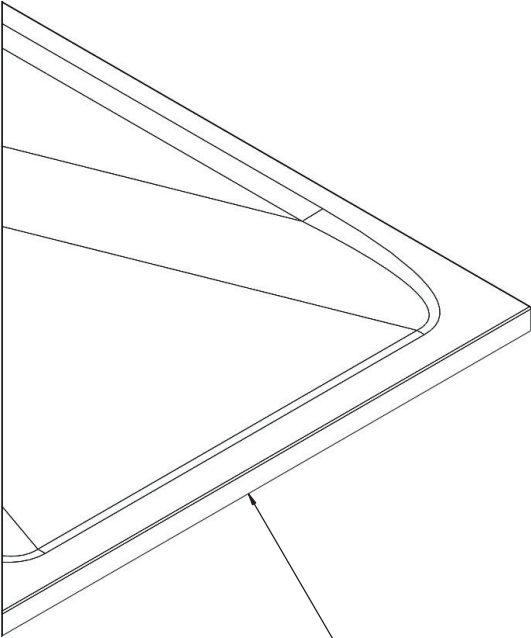
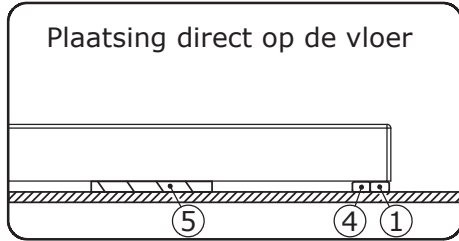

Vlakke niet-vochtige vloer is essentieel

Plaatsing tegen het tegelwerk

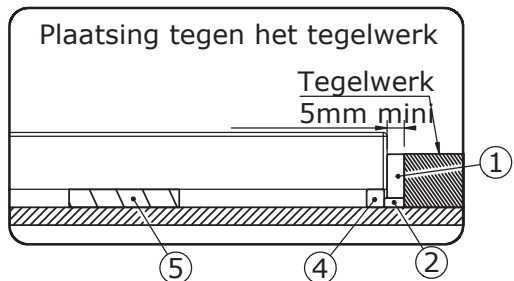

## KINEROCK EVO-INSTALLATIEMOGELIJKHEDEN

## KINEROCK EVO VIERKANT EN RECHTHOEKIG

## 1. Geïnstalleerd op in hoogte verstelbare poten en afgewerkt met tegels

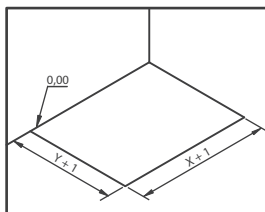
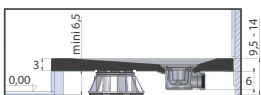

Voorbereiding montage



X	Y	B	C	D
80	80	25	-	5,5
90	90	35	-	15,5
70	70		22,5	22,5
75	75		25	25
80	80		27,5	27,5
90	90		32,5	32,5
100	100		37,5	37,5
90	70		22,5	19,5
100	70		22,5	19,5
100	80		27,5	24,5
100	90		32,5	29,5
110	70		22,5	19,5
110	80		27,5	24,5
120	70		22,5	24,5
120	80		27,5	24,5
120	90		32,5	29,5
120	100		37,5	29,5
130	70		22,5	19,5
130	80		27,5	24,5
140	70		22,5	19,5
140	80		27,5	24,5
140	90		32,5	29,5
140	100		37,5	29,5
150	70		22,5	19,5
150	80		27,5	24,5
150	90		32,5	29,5
160	70		22,5	19,5
160	80		27,5	24,5
160	90		32,5	29,5
160	100		37,5	29,5
170	70		22,5	19,5
170	80		27,5	24,5
170	90		32,5	24,5
180	80		27,5	24,5
180	90		32,5	29,5
180	100		37,5	29,5
190	90		32,5	29,5
200	100		37,5	19,5

## 2. Geïnstalleerd half verzonken tegen de tegels

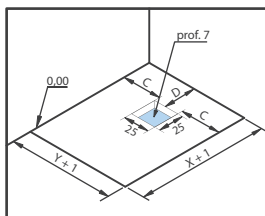
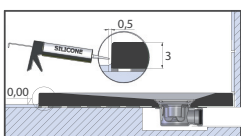
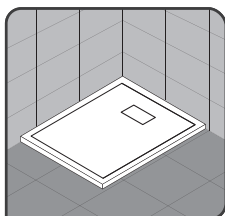

Voorbereiding montage

## 3. Ingebouwd met in hoogte verstelbare poten

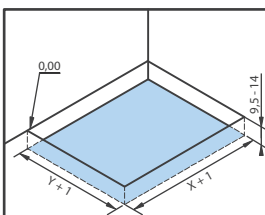
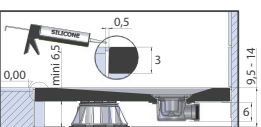

Voorbereiding montage

## 4. Ingebouwd zonder in hoogte verstelbare poten

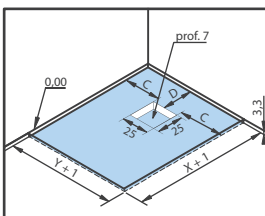
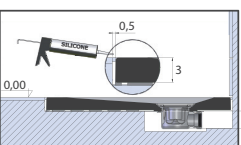
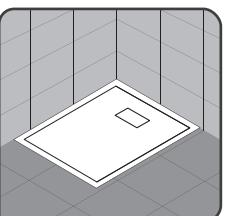

Voorbereiding montage

# KINEROCK EVO-INSTALLATIEMOGELIJKHEDEN

## KINEROCK EVO 1/4 ROND

1. Geïnstalleerd op in hoogte verstelbare poten en afgewerkt met tegels

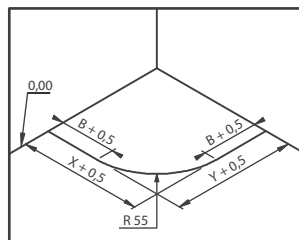
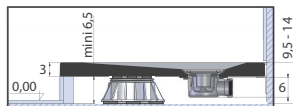

Voorbereiding montage

2. Geïnstalleerd half verzonken tegen de tegels

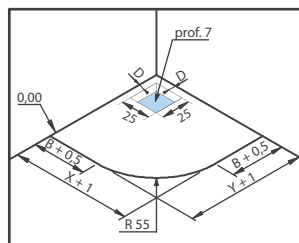
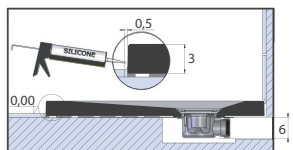
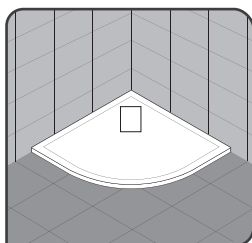

Voorbereiding montage

3. Ingebouwd met in hoogte verstelbare poten

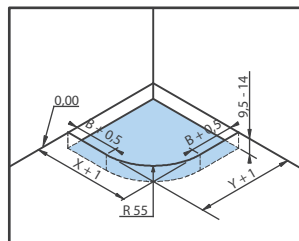
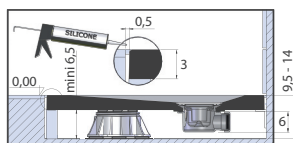

Voorbereiding montage

4. Ingebouwd zonder in hoogte verstelbare poten

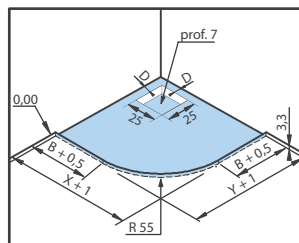
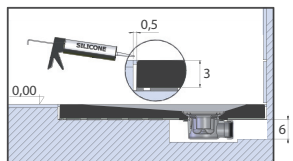
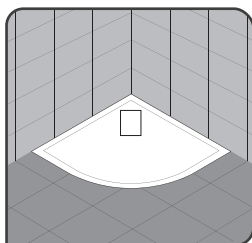

Voorbereiding montage

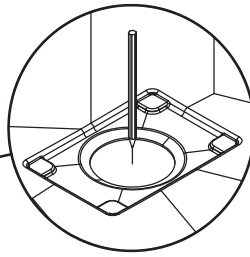
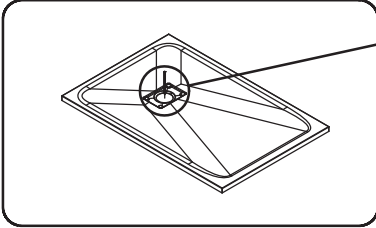
**D**

Position für den Ablauf anzeichnen  
und vormontieren.

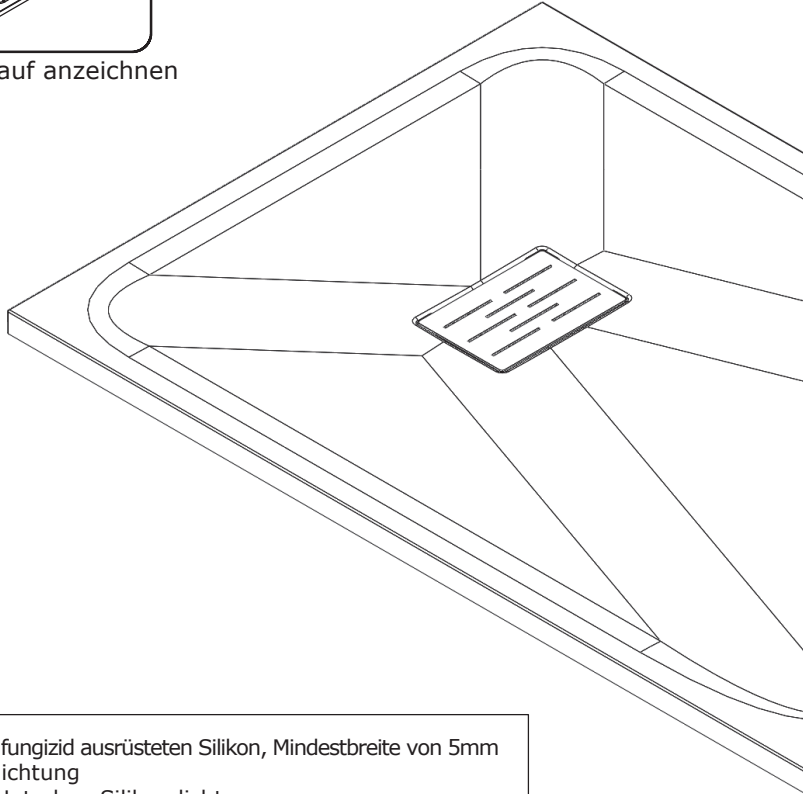

- ① - Fugenabschluss mit fungizid ausgerüsteten Silikon, Mindestbreite von 5mm
- ② - flexible Silikonabdichtung
- ③ - Träger Element/Unterbau Silikondichtung
- ④ - Silikonträger
- ⑤ - Polyurethan-Klebstoff oder MS-Polymer

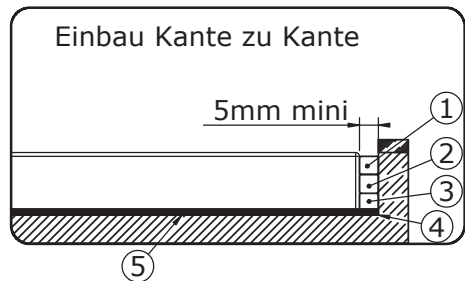
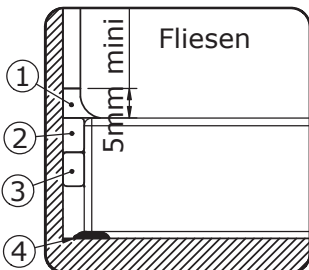



Montage eines Unterdruckventils wird benötigt, wenn eine andere Vorrichtung an den gleichen Ablauf angeschlossen ist.

Während den Installationsarbeiten auf ausreichenden Schutz gegen aggressive Mittel achten: Verbrennungen, Stöße, Kratzer oder Abbeizmittel...

Verwenden Sie keine säurehaltigen oder andere aggressive Entfetter.

freie Aufstellung auf  
Fertigfußboden

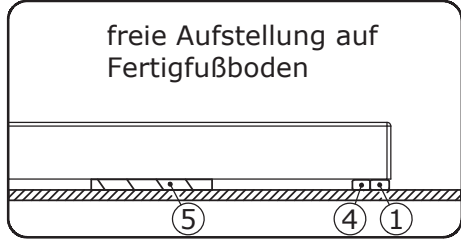

Auf festen, planen und nicht feuchten Boden achten.

einseitiger Wannenanschluß

Fliesen  
5mm mini

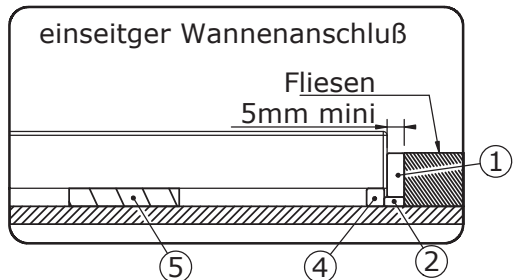

## KINEROCK EVO-INSTALLATIONSARTEN

## KINEROCK EVO QUADRATISCH UND RECHTECKIG

## 1. Montage auf Fertigfußboden mit Wannenfüßen und Fliesensockel

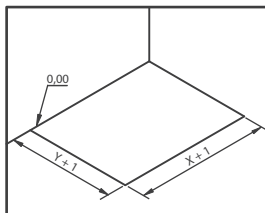
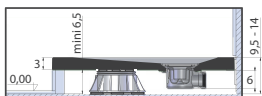
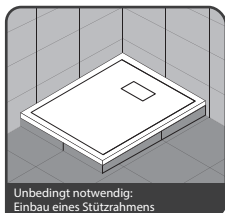

Montagevorbereitung



X	Y	B	C	D
80	80	25	-	5,5
90	90	35	-	15,5
70	70		22,5	22,5
75	75		25	25
80	80		27,5	27,5
90	90		32,5	32,5
100	100		37,5	37,5
90	70		22,5	19,5
100	70		22,5	19,5
100	80		27,5	24,5
100	90		32,5	29,5
110	70		22,5	19,5
110	80		27,5	24,5
120	70		22,5	24,5
120	80		27,5	24,5
120	90		32,5	29,5
120	100		37,5	29,5
130	70		22,5	19,5
130	80		27,5	24,5
140	70		22,5	19,5
140	80		27,5	24,5
140	90		32,5	29,5
140	100		37,5	29,5
150	70		22,5	19,5
150	80		27,5	24,5
150	90		32,5	29,5
160	70		22,5	19,5
160	80		27,5	24,5
160	90		32,5	29,5
160	100		37,5	29,5
170	70		22,5	19,5
170	80		27,5	24,5
170	90		32,5	24,5
180	80		27,5	24,5
180	90		32,5	29,5
180	100		37,5	29,5
190	90		32,5	29,5
200	100		37,5	19,5

## 2. Montage auf Fliesenboden aufliegend

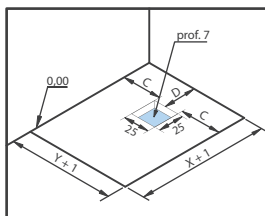
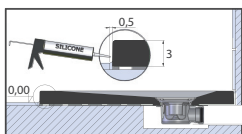
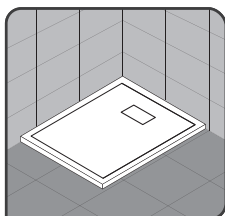

Montagevorbereitung

## 3. Bodengleiche Montage mit Wannenfüßen

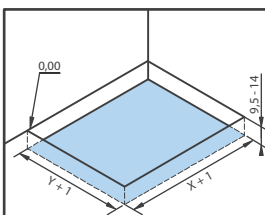
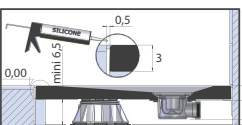

Montagevorbereitung

## 4. Bodengleiche Montage ohne Wannenfüße

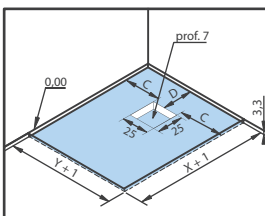
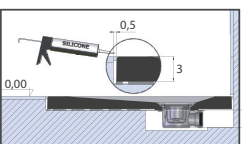
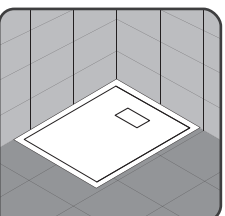

Montagevorbereitung

# KINEROCK EVO-INSTALLATIONSARTEN

## KINEROCK EVO 1/4 RUNDE

### 1. Montage auf Fertigfußboden mit Wannenfüßen und Fliesensockel

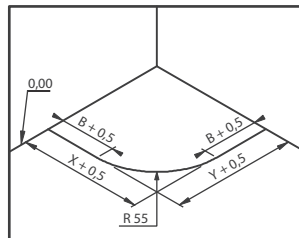
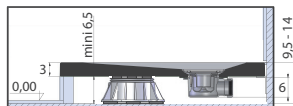

Montagevorbereitung

### 2. Montage auf Fliesenboden aufliegend

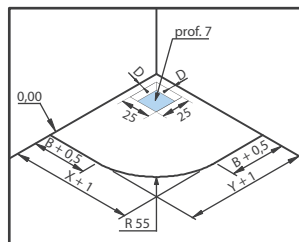
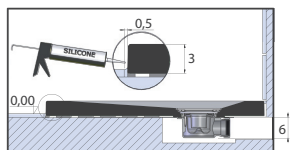
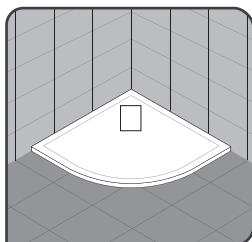

Montagevorbereitung

### 3. Bodengleiche Montage mit Wannenfüßen

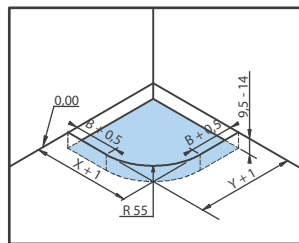
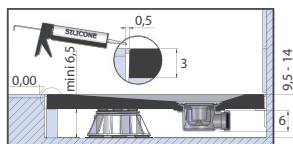

Montagevorbereitung

### 4. Bodengleiche Montage ohne Wannenfüße

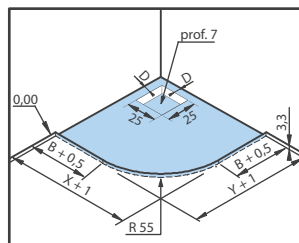
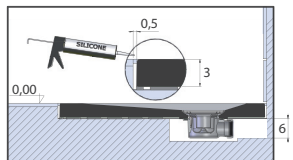
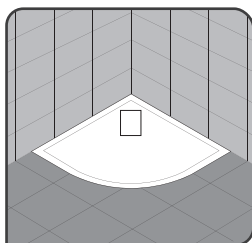

Montagevorbereitung

- Ⓕ Mise en place des plots de colle polyuréthane ou MS polymère
- ⒼⒸ Loading the plots glue polyurethane or MS polymer
- Ⓔ Ubicacion de los puntos de pegamento poliuretano o polimero MS
- Ⓘ Posizione dei punti di colla poliuretanica o MS polimero
- ⓂⒻ Breng de polyurethaan lijm of MS polymeer aan op de juiste plaats
- Ⓓ Bringen Sie den Polyurethan-/MS-Polymere-Kleber auf

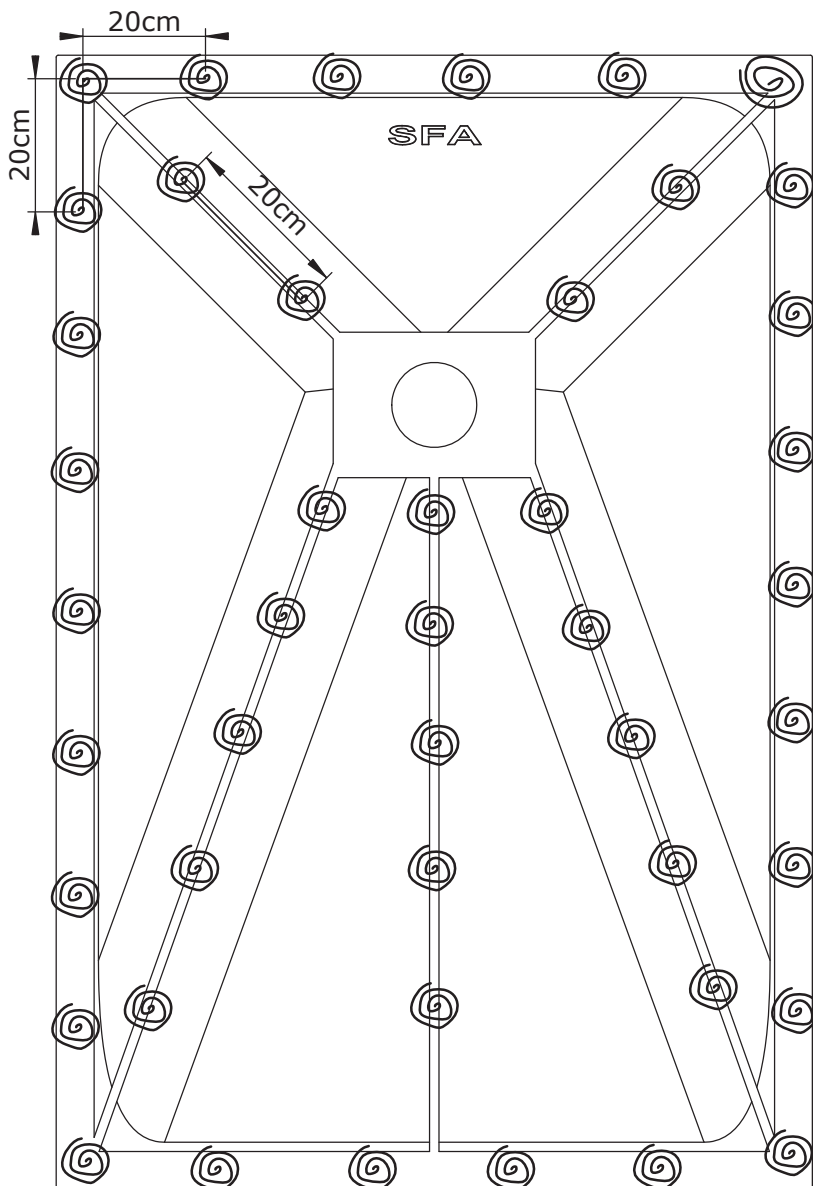





24h

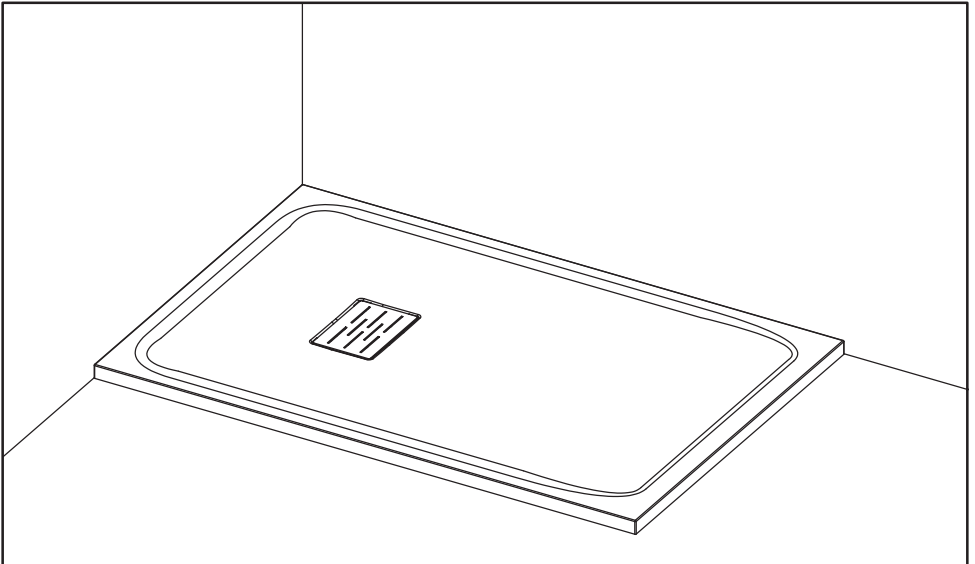





AQUAPRODUCTION, Site industriel,  
F - 44680 Chaumes-en-Retz

20

**EN 14527 - CL2**

Aptitude au nettoyage : satisfaisant

Durabilité : satisfaisant



**SAV**  
**SERVICE HELPLINES**  
**ASSISTENZA POST- VENDITA**  
**SERVICIO POSTVENTA**

**FRANCE**

02 40 21 29 45

**UK**

020 8842 0033

**IRELAND**

04697 33102

**DEUTSCHLAND**

+49 (0) 6074 / 30928 0

**ITALIA**

(0382) 6181

**ÖSTEREICH**

+43 1 710 60 70

**SCHWEIZ**

(01) 748 17 44

**ESPANA**

93 544 60 76

**NEDERLAND**

+31 475 487 100

**BELGIË**

+31 475 487 100

**BELGIQUE**

+31 475 487 100

**РОССИЯ**

963 19 40, 773 67 22

**PORTUGAL**

219 112 785