

AC073 - AC075

Deck-mounted bathtub set

Miscelatore bordo vasca

Mitigeur de baignoire pour montage sur gorge

Badewannebatterie für Randmontage

Monomando para borde de bañera

Badrandcombinatie eenhendel mengkraan

hotbath
italian bathroomware



AC073



AC075

Including drip draining kit suitable for combination with our bathtub wastes articles P032-P033













Incluso sgocciolatoio drenante adatto alla combinazione con le nostre colonne di scarico vasca articoli P032-P033

Système anti-gouttes inclus, compatible avec nos vidanges de baignoire articles P032-P033

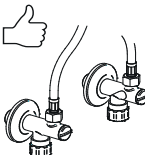
Inklusive Schlauchdurchführung, geeignet für die Kombination mit unseren Badewanne Überlaufgarnituren Artikel P032-P033

Inclusief baddoorvoerset, geschikt voor combinatie met onze badoverloopsets item P032-P033

BEFORE STARTING / PRIMA DI INIZIARE / AVANT DE COMMENCER / ANTES DE EMPEZAR / VOR DEM START / VOORDAT JE BEGINT

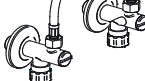
 P bar	 MAX 5 1 MIN	 3 1		 15s		 FILTER TAPS RECOMMENDED
 T °C	 MAX 80	 60 45				

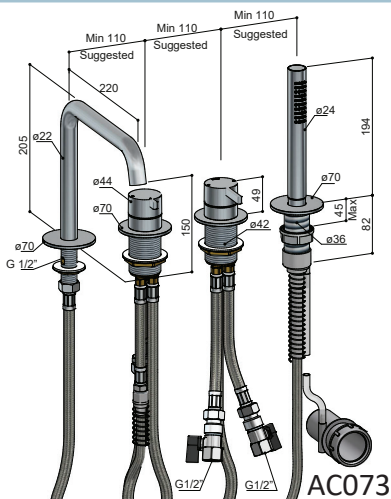

Inspection hatch recommended
 Consigliato sportello d'ispezione
 Trappe de visite recommandée
 Revisionsöffnung empfohlen
 Trampilla de inspección recomendada
 Inspectieluik aanbevelen

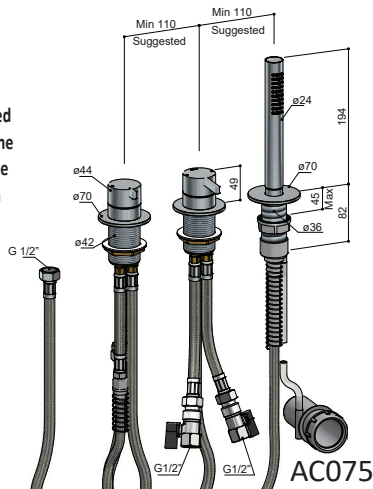

FLEXIBLE HOSES FOR DIVERTER
FLESSIBILI PER DEVIATORE
FLEXIBLES POUR INVERSEUR
SCHLÄUCHE FÜR UMSTELLER
FLEXIBLES PARA INVERSOR
AANSLUITSLANGEN VOOR OMSTEL

(A)
 Inlet – Entrata
 Entrée – Einlauf
 Entrada – Inlaet **INLET**

(B)
 Outlet to hand shower – Uscita per doccia
 Sortie pour douche – Auslauf für Handbrause
 Salida a teleducha – Uitlaat naar handdouché

(C)
 Outlet to spout – Uscita per bocca
 Sortie pour bec – Auslass für Auslauf
 Salida a caño – Uitlaat naar uitloop

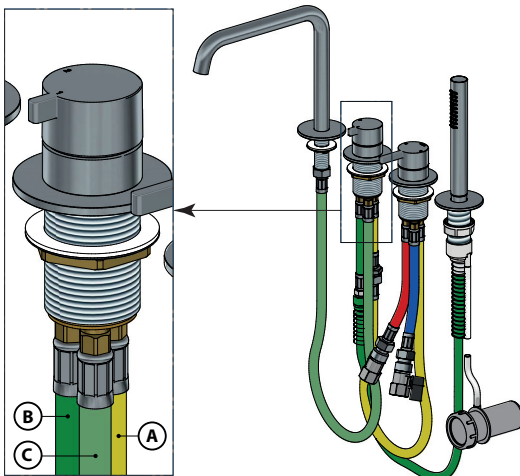

INSTALLATION

MIXER

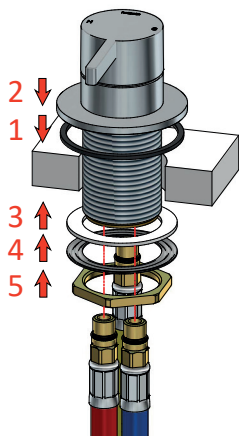

1

DIVERTER

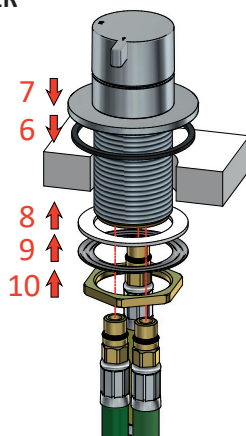

2

SPOUT

3

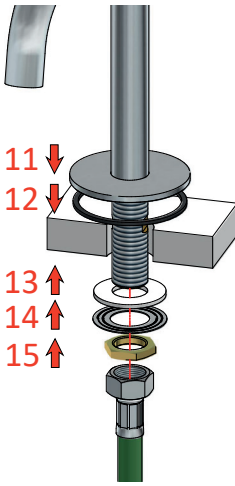

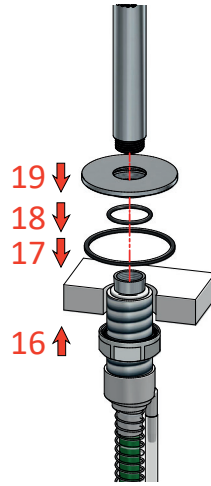

SHOWER

4



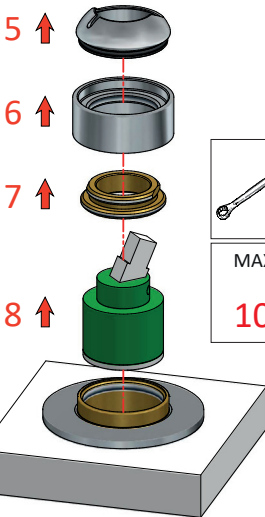
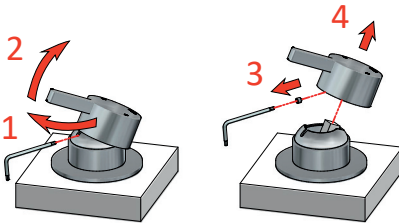

MIXER

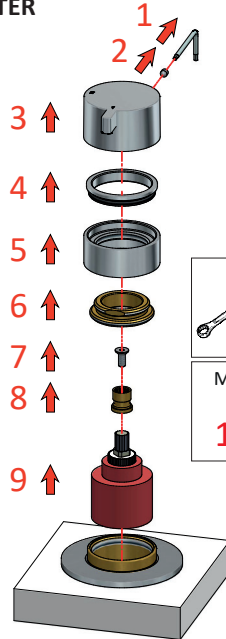

	
30	
MAX TIGHTENING TORQUE	
10-12 Nm	

DIVERTER



	
30	
MAX TIGHTENING TORQUE	
10-12 Nm	

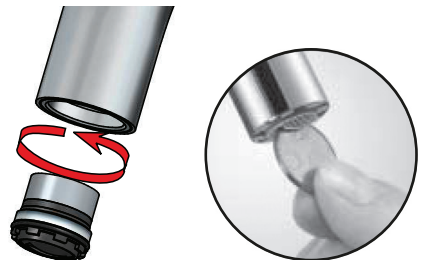

CLEANING - PULIZIA - NETTOYAGE - REINIGUNG - LIMPIEZA - REINIGING

						WARNING	
CR CHROME	WATER ✓	LIQUID SOAP ✓	SMOOTH CLOTH ✓	ABRASIVE SPONGE ✗	ACID/ABRASIVE DETERGENT ✗	Inoxidable electrolytic finish Finitura elettrolitica inossidabile Finition électrolytique inoxydable	Inoxidierbare elektrolytische Ausführung Acabado electrofítico inoxidable Inoxidable elektrolitische afwerking
GN BRUSHED NICKEL	WATER ✓	LIQUID SOAP ✓	SMOOTH CLOTH ✓	ABRASIVE SPONGE ✗	ACID/ABRASIVE DETERGENT ✗	Inoxidable electrolytic finish Finitura elettrolitica inossidabile Finition électrolytique inoxydable	Inoxidierbare elektrolytische Ausführung Acabado electrofítico inoxidable Inoxidable elektrolitische afwerking
BBP BRUSHED BRASS PVD	WATER ✓	LIQUID SOAP ✓	SMOOTH CLOTH ✓	ABRASIVE SPONGE ✗	ACID/ABRASIVE DETERGENT ✗	Inoxidable PVD finish Finitura PVD inossidabile Finition PVD inoxydable	Inoxidierbare PVD Ausführung Acabado PVD inoxidable Inoxidable PVD afwerking
BCP BRUSHED COPPER PVD	WATER ✓	LIQUID SOAP ✓	SMOOTH CLOTH ✓	ABRASIVE SPONGE ✗	ACID/ABRASIVE DETERGENT ✗	Inoxidable PVD finish Finitura PVD inossidabile Finition PVD inoxydable	Inoxidierbare PVD Ausführung Acabado PVD inoxidable Inoxidable PVD afwerking
MBP MATT BLACK PVD	WATER ✓	LIQUID SOAP ✓	SMOOTH CLOTH ✓	ABRASIVE SPONGE ✗	ACID/ABRASIVE DETERGENT ✗	Inoxidable PVD finish Finitura PVD inossidabile Finition PVD inoxydable	Inoxidierbare PVD Ausführung Acabado PVD inoxidable Inoxidable PVD afwerking
PBP POLISHED BLACK PVD	WATER ✓	LIQUID SOAP ✓	SMOOTH CLOTH ✓	ABRASIVE SPONGE ✗	ACID/ABRASIVE DETERGENT ✗	Inoxidable PVD finish Finitura PVD inossidabile Finition PVD inoxydable	Inoxidierbare PVD Ausführung Acabado PVD inoxidable Inoxidable PVD afwerking

**TERMS OF SALE AND WARRANTY
CONDIZIONI DI VENDITA E GARANZIA
CONDITIONS DE VENTE ET GARANTIE
CONDICIONES DE VENTA Y GARANTÍA
VERKAUFSBEDINGUNGEN UND GARANTIE
VERKOOP- EN GARANTIEVOORWAARDEN**

**NETHERLANDS
BELGIUM
LUXEMBOURG
UK AND IRELAND**

**ALL COUNTRIES
(EXCEPTED BENELUX, UK AND IRELAND)**

<https://www.hotbath.nl/garantie>

<https://hotbath.it/en/termsofsale>



Hotbath B.V.
Nieuwland Parc 210
2952 DC Alblasserdam
Nederland
E info@hotbath.nl
W hotbath.nl



Hotbath Srl
Via Marco Polo 135/D
I-55049 Viareggio
Italy
E info@hotbath.it
W hotbath.it

hotbath
italian bathroomware