

V-exact II



Thermostatic Radiator Valves

Thermostatic valve body with
stepless precision presetting

*Engineering
GREAT Solutions*

V-exact II

V-exact II thermostatic valve bodies are used in two-pipe warm water pump heating systems with normal to high temperature spread. The integrated stepless precision presetting makes precise hydraulic balancing possible with the aim of providing all heat consumers with hot water according to their heat requirements. The valve has a large flow range and is characterized by an optimized noise performance and very low flow tolerances.



Key features

- > **Optimised noise behaviour**
Through specially designed setting
- > **High flow range**
For various applications
- > **Double O-ring seal**
For durable and maintenance free operation
- > **Valve body in gunmetal**
Corrosion-resistant and safe

Technical description

Applications area:

Heating and cooling systems.

Function:

Control
Stepless presetting
Shut-off

Dimensions:

DN 10-20

Pressure class:

PN 10

Temperature:

Max. working temperature: 120°C, with protection cap or actuator 100°C, with press connection 110°C.
Min. working temperature: -10°C.

Materials:

Valve body: Corrosion resistant Gunmetal.
O-rings: EPDM rubber
Valve disc: EPDM rubber
Return spring: Stainless steel
Valve insert: Brass, PPS (polyphenylsulphide)
The complete thermostatic insert can be replaced using the IMI Heimeier fitting tool without draining the system.
Spindle: Niro-steel spindle with double O-ring sealing.

Surface treatment:

Valve body and fittings are nickel-plated.

Marking:

THE, country code, flow direction arrow, DN and KEYMARK-Designation. II+ - Designation.
White protection cap.

Standards:

V-exact II valves meet the following requirements:
– KEYMARK certified and tested to DIN EN 215.



– the “highly expanded version” and the “standard version” of the specification FW 507 drawn up by the Arbeitsgemeinschaft Fernwärme (AGFW) (Working Group for District Heating).



Pipe connection:

The female-threaded version is designed for connection to threaded pipe, or in conjunction with compression fittings, to copper precision steel or multi-layer pipe (only DN 15). The male-threaded version, in conjunction with the appropriate compression fittings, permits connection to plastic pipe. Versions with Viega press connection (15 mm) with SC-Contur are suitable for copper, Viega Sanpress stainless-steel, and Prestabo steel pipe.

Connection to thermostatic head and actuator:

IMI Heimeier M30x1.5

Construction

V-exact II

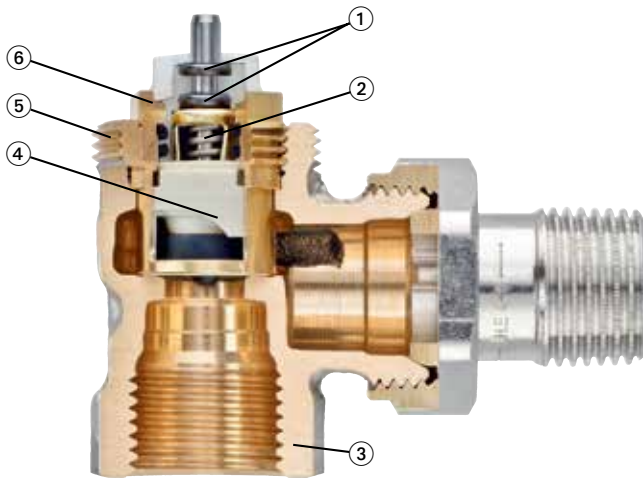

1. Long-life double O-ring sealing.
2. Strong return spring in combination with high locating force ensures that the valve does not slacken off over time.
3. Valve body in corrosion-resistant gunmetal.
4. Precise regulating part for accurate stepless presetting.
5. M30x1.5 connection technology for IMI Hydronic Engineering thermostatic heads and actuators.
6. Upper section replaceable using the fitting tool without draining the system.

Application

The thermostatic valve body V-exact II is applied in two-pipe pumped hot-water heating system with normal to high temperature spread, as well as in cooling systems. The valve has a wide flow range as well as optimised noise behaviour and very tight flow tolerances.

In extensive systems, even water distribution should be maintained not only during specified normal operation, but also after a drop in room temperature or a break in operations,

in order to avoid under or over-supply to parts of the system. To achieve this, the valve characteristic is designed so that the radiator mass-flow does not exceed about 1.3 times the nominal flow even at Preset 8 and with a fully-open valve. Corresponding to the standards EnEV and DIN V 4701-10, V-exact II thermostatic valve bodies can be designed with a p-band of up to max. 1 K or max. 2 K.

Optimized flow restriction

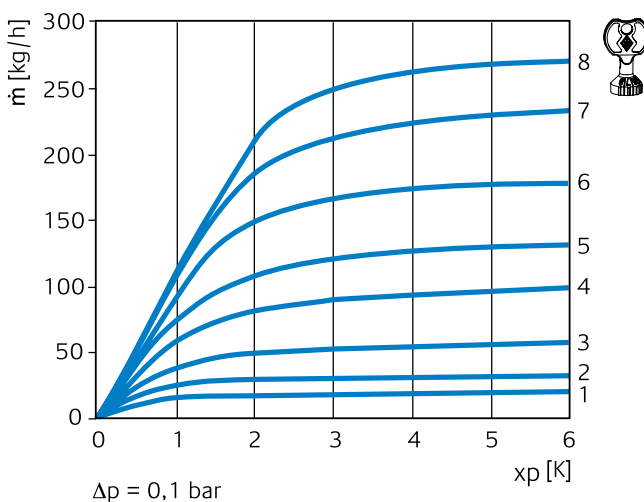

Noise behaviour

To ensure low-noise performance, the following conditions must be met:

- On the basis of experience, the differential pressure over the thermostatic valves should not exceed about 20 kPa = 200 mbar = 0.2 bar. If in designing the system, higher transient differentials might be experienced in the part-load flow range, differential pressure control equipment such as a STAP Differential Pressure Controller or Hydrolux bypass valves can be used (see diagram for noise characteristic curve).
- Mass-flow must be correctly adjusted.
- The system must be completely deaerated.

Lowest flow tolerances

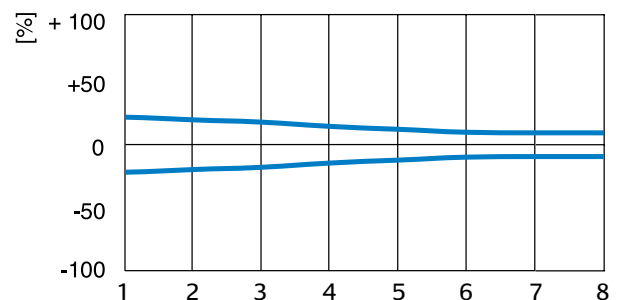

Sample application

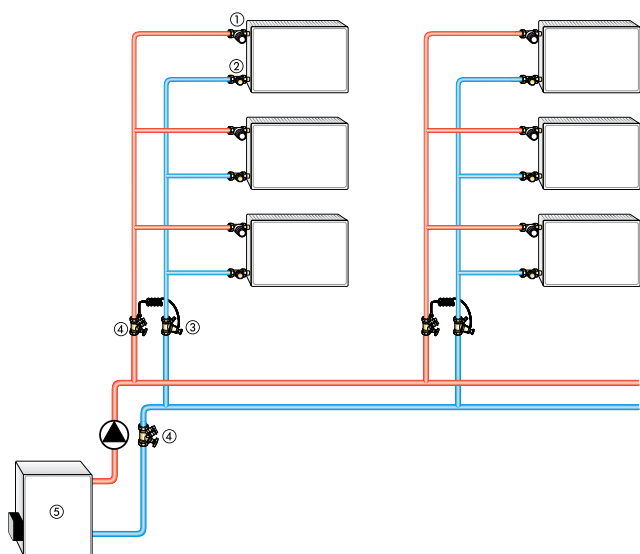

1. V-exact II thermostatic valve body
2. Regulux/Regutec lockshield
3. STAP differential pressure controller
4. STAD balancing valve
5. Boiler

Notes

– To avoid damage and the formation of scale deposit in the hot-water heating system, the composition of the heat transfer medium should be in accordance with the VDI guideline 2035. For industrial and long-distance energy systems, see the applicable codes VdTÜV and 1466/AGFW FW 510. A heat transfer medium containing mineral oils, or any type of lubricant containing mineral oil can have extremely negative effects and usually lead to the disintegration of EPDM seals. When using nitrite-free frost and corrosion resistance solutions with an ethylene glycol base, pay close attention to the details outlined in the manufacturers' documentation, particularly concerning concentration and specific additives.

- Flush the system before changing thermostatic valves in heavy polluted existing systems.
- The thermostatic valve bodies can be used with all HEIMEIER thermostatic heads and HEIMEIER or TA thermal or motorized actuators. The optimal tuning of the components guarantees maximum safety. When using actuators from other manufacturers, make sure that the pressure power is appropriate for thermostatic valve bodies with soft sealing valve discs..

Press-Line Connection with Viega SC-Contur

Thermostatic valve bodies with 15 mm Viega press connection are suitable for copper pipes conforming to EN 1057 as well as Viega Sanpress stainless steel and Prestabo steel pipes. All press connections as well as the valve bodies are made of corrosion-resistant, dezincification-free gunmetal. Since this is a Viega press connection, all suitable Viega press-fitting jaws can be used. This means there is no need to purchase costly press-fitting tools and jaws.

The pressing action is produced by a formed hexagon recess before and after the beading of the connector and gives the press-fitted joint the necessary strength. In addition, the press-fitting beading is specifically formed such as to give the highgrade EPDM sealing element its defined shape.

In the interest of safety, the press connections are equipped with SC-Contur (SC = safety connection) which makes it possible to detect non-pressed joints by visible leaks when filling the system. During the press-fitting operation, the SC-Contur is practically reformed and loses its effect in the process, thus producing a permanent, tight and positive joint connection.

Initially, press-fitting joints that do not feature SC-Contur can appear to be tight in the non-pressed state, however, they can slide apart during subsequent operation of the system. The hexagon on the valve bodies is a particularly practical feature for holding the fittings while tightening the union nut.

The following press-fitting tools can be used, e.g.

- Viega: Type 2, PT3-H, PT3-EH, PT3-AH, battery-powered Presshandy, Pressgun 4E/4B
- Geberit: PWH 75
- Geberit /Novopress: Type N 230V, Type N battery-powered
- Mapress/Novopress: EFP 2, ACO 1/ ECO 1
- Klauke: UAP 2

The suitability of other press-fitting tools should be verified with the respective manufacturer.

We recommend using only Viega press-fitting jaws to make Viega press connections.

Operation

Presetting

The presetting can be selected steplessly between 1 and 8. There are 7 additional marks between the preset values, thus enabling exact setting. Setting 8 corresponds to the standard setting (factory setting). The technician can undertake or change the setting with the setting key or spanner (13 mm). This ensures unauthorised persons cannot tamper with the setting.

- Plug the setting key or universal key into the valve insert and turn until it engages in position.
- Turn the index of the desired setting value to the index figure of the valve insert.
- Withdraw the key. The setting on the valve insert is visible from the actuating direction (see fig.).

Front-end visibility

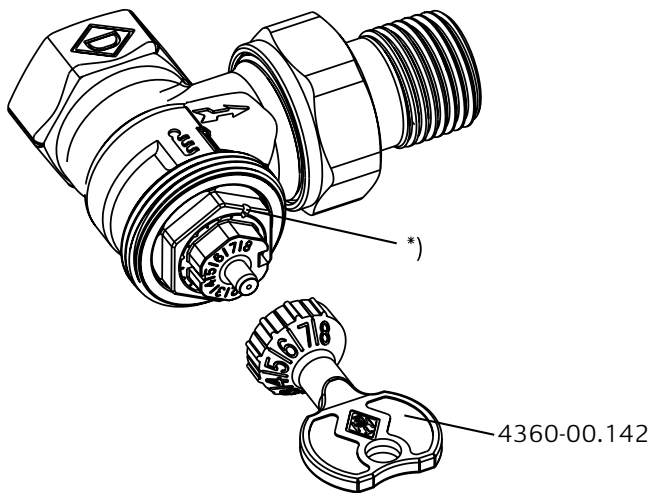

*) Index

Technical data

Diagram, valve body with thermostatic head

P-band [xp] **1.0 K**

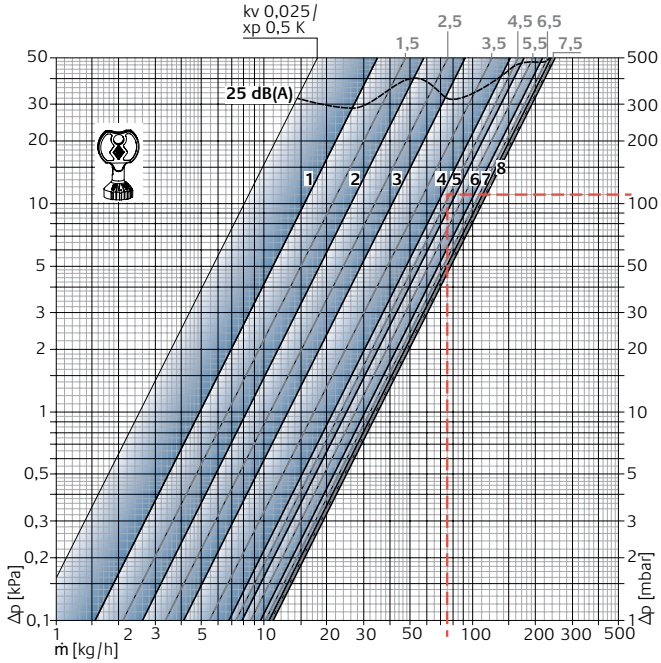

P-band [xp] **2.0 K**

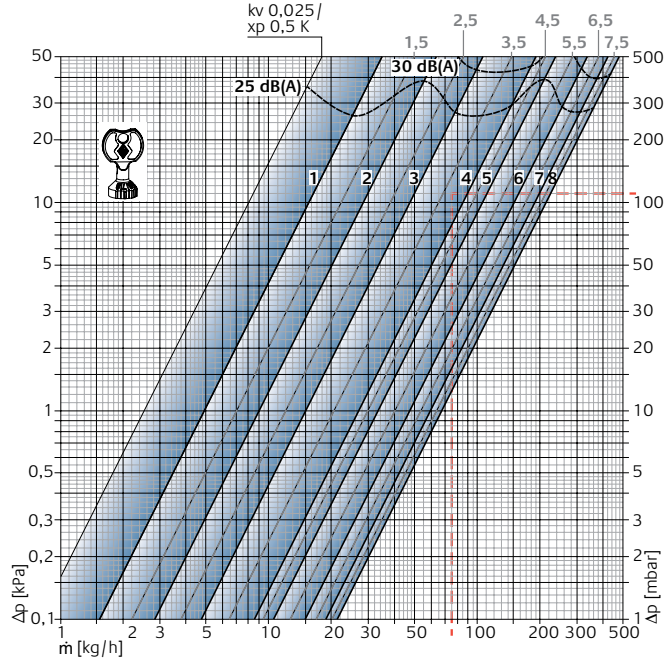

Valve body (DN 10/15/20) with thermostatic head

		Presetting								Permitted differential pressure, during which the valve is kept closed Δp [bar]		
		1	2	3	4	5	6	7	8	Th.-head	EMO T-TM/NC EMOtec/NC EMO 3 EMOLON	EMO T/NO EMOtec/NO
P-band [xp] 1.0K	kv-value	0,049	0,082	0,130	0,215	0,246	0,303	0,335	0,343	1,0	3,5	3,5
P-band [xp] 2.0K	kv-value	0,049	0,090	0,150	0,265	0,330	0,470	0,590	0,670			
	Kvs	0,049	0,102	0,185	0,313	0,420	0,565	0,740	0,860			
	Flow tolerance ± [%]	20	18	16	14	12	10	10	10			

Kv/Kvs = m³/h at a pressure drop of 1 bar.

Sample calculation

Target:
Setting range

Given:
Heat flow Q = 1308 W
Temperature spread ΔT = 15 K (65/50 °C)
Pressure loss, thermostatic valve ΔpV = 110 mbar

Solution:
Mass flow m = Q / (c · ΔT) = 1308 / (1,163 · 15) = 75 kg/h

$$Cv = \frac{Kv}{0,86}$$

Setting range from Diagram:
With P-band **max. 1.0 K**: 4,5
With P-band **max. 2.0 K**: 4

$$Kv = Cv \cdot 0,86$$

Presetting table

Presetting values for various radiator performances, pressure drops, and system spread

Q [W]		200	250	300	400	500	600	700	800	900	1000	1200	1400	1600	1800	2000	2200	2400	2600	2800	3000	3200	3400	3600	3800	4000	4800	5300	6500	6800	8400	9000	12000																				
ΔT [K]	Δp [kPa]																																																				
10	5	2	3	3	4	4	4	5	5	6	6	6	7	8																																							
	10	2	2	2	3	3	4	4	4	4	5	5	6	6	7	7	8	8																																			
	15	2	2	2	3	3	3	4	4	4	4	5	5	6	6	6	7	7	7	8	8																																
15	5	2	2	2	3	3	4	4	4	4	4	5	6	6	6	7	7	7	8																																		
	10	1	1	2	2	3	3	3	3	4	4	4	4	5	5	6	6	6	7	7	7	7	8	8																													
	15	1	1	1	2	2	3	3	3	3	3	4	4	4	5	5	5	6	6	6	6	7	7	7	7	8																											
20	5	1	1	2	2	3	3	3	4	4	4	4	5	5	6	6	6	6	7	7	7	8	8																														
	10	1	1	1	2	2	2	3	3	3	3	4	4	4	4	5	5	5	6	6	6	6	6	7	7	7	8																										
	15	1	1	1	2	2	2	3	3	3	3	4	4	4	4	4	5	5	5	6	6	6	6	6	6	6	6	6	6	7	8																						
40	5	1			1	1	2	2	2	2	3	3	3	4	4	4	4	4	4	5	5	5	5	6	6	6	6	7	8	8																							
	10	1			1	1	1	2	2	2	2	3	3	3	3	3	4	4	4	4	4	4	4	5	5	4	4	4	5	5	5	6	6	6	7	7																	
	15	1			1	1	1	1	2	2	2	2	2	3	3	3	3	3	4	4	4	4	4	4	4	4	4	4	4	4	4	5	6	6	6	7	8																

10 kPa = 100 mbar = 1 mWS

Presetting value at max. 2 K P-band.

Q = radiator performance

ΔT = system spread

Δp = Differential pressure

Example:

Q = 1000 W, ΔT = 15 K, Δp = 10 kPa

Presetting value: **4**

Tips:

For an approximate determination of the preset for given radiator performance and system spread, an average differential pressure of 10 kPa is recommended.

For systems that are widely extended horizontally, a differential pressure drop is necessary:

eg, 15 kPa for valves near the central unit, 10 kPa for valves at a medium range, and 5 kPa for valves on remote radiators.

An exact determination can only be carried out by making a pipe network calculation using the diagram, or with a calculation program.

Articles

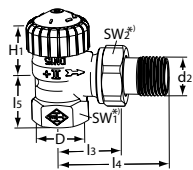
Angle

DN	D	d2	I3	I4	I5	H1	Kv p-band max. 2 K	Kvs	EAN	Article No
10	Rp3/8	R3/8	26	52	23,5	23,5	0,025 – 0,670	0,86	4024052838318	3711-01.000
15	Rp1/2	R1/2	29	58	27	23,5	0,025 – 0,670	0,86	4024052838417	3711-02.000
20	Rp3/4	R3/4	34	66	29	21,5	0,025 – 0,670	0,86	4024052838516	3711-03.000

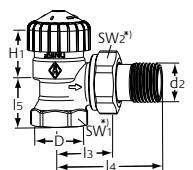
Angle

with reduced lengths.

Brass. Not suitable for compression fitting for multi layer pipes.

DN	D	d2	I3	I4	I5	H1	Kv p-band max. 2 K	Kvs	EAN	Article No
10	Rp3/8	R3/8	24	49	20	24	0,025 - 0,670	0,86	4024052923014	3451-01.000
15	Rp1/2	R1/2	26	53	23	23,5	0,025 - 0,670	0,86	4024052922918	3451-02.000
20	Rp3/4	R3/4	30	63	26	21,5	0,025 - 0,670	0,86	4024052927814	3451-03.000

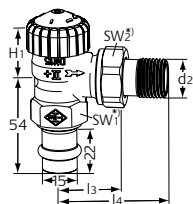
Angle

with ViEGA press connection 15 mm

DN	d2	I3	I4	H1	Kv p-band max. 2 K	Kvs	EAN	Article No
15	R1/2	29	58	23,5	0,025 – 0,670	0,86	4024052840014	3717-15.000

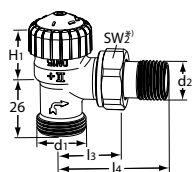
Angle

with male thread G 3/4

DN	d1	d2	I3	I4	H1	Kv p-band max. 2 K	Kvs	EAN	Article No
15	G3/4	R1/2	29	58	21,5	0,025 – 0,670	0,86	4024052840212	3719-02.000

*) SW1: DN 10 = 22 mm, DN 15 = 27 mm, DN 20 = 32 mm

SW2: DN 10 = 27 mm, DN 15 = 30 mm, DN 20 = 37 mm

Values H1 and H2 are at the bearing surface thermostatic head or actuator.

 Kvs = m³/h at a pressure drop of 1 bar and fully open valve.

 Kv [xp] max. 2 K = m³/h at a pressure drop of 1 bar with thermostatic head.

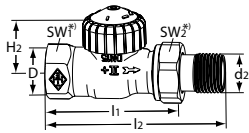

Straight

DN	D	d2	l1	l2	H2	Kv p-band max. 2 K	Kvs	EAN	Article No
10	Rp3/8	R3/8	59	85	21,5	0,025 – 0,670	0,86	4024052838615	3712-01.000
15	Rp1/2	R1/2	66	95	21,5	0,025 – 0,670	0,86	4024052838714	3712-02.000
20	Rp3/4	R3/4	74	106	23,5	0,025 – 0,670	0,86	4024052838912	3712-03.000

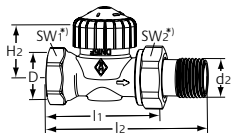

Straight

with reduced lengths.

Brass. Not suitable for compression fitting for multi layer pipes.

DN	D	d2	l1	l2	H2	Kv p-band max. 2 K	Kvs	EAN	Article No
10	Rp3/8	R3/8	50	76	22,5	0,025 - 0,670	0,86	4024052926817	3452-01.000
15	Rp1/2	R1/2	55	83	22,5	0,025 - 0,670	0,86	4024052926916	3452-02.000
20	Rp3/4	R3/4	65	97	22,5	0,025 - 0,670	0,86	4024052927913	3452-03.000

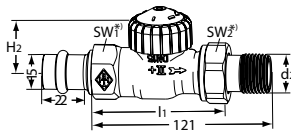

Straight

with Viega press connection 15 mm

DN	d2	l1	H2	Kv p-band max. 2 K	Kvs	EAN	Article No
15	R1/2	66	21,5	0,025 – 0,670	0,86	4024052840113	3718-15.000

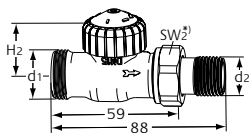

Straight

with male thread G 3/4

DN	d1	d2	H2	Kv p-band max. 2 K	Kvs	EAN	Article No
15	G3/4	R1/2	21,5	0,025 – 0,670	0,86	4024052840311	3720-02.000

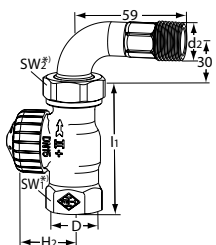

Straight

with bended nipple

DN	D	d2	l1	H2	Kv p-band max. 2 K	Kvs	EAN	Article No
15	Rp1/2	R1/2	66	21,5	0,025 – 0,670	0,86	4024052840717	3756-02.000

*) SW1: DN 10 = 22 mm, DN 15 = 27 mm, DN 20 = 32 mm

SW2: DN 10 = 27 mm, DN 15 = 30 mm, DN 20 = 37 mm

Values H1 and H2 are at the bearing surface thermostatic head or actuator.

Kvs = m³/h at a pressure drop of 1 bar and fully open valve.

Kv [xp] max. 2 K = m³/h at a pressure drop of 1 bar with thermostatic head.

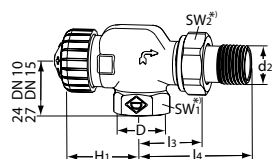

Axial

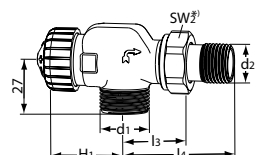
DN	D	d2	l3	l4	H1	Kv p-band max. 2 K	Kvs	EAN	Article No
10	Rp3/8	R3/8	26	52	31,5	0,025 – 0,670	0,86	4024052838011	3710-01.000
15	Rp1/2	R1/2	29	58	31,5	0,025 – 0,670	0,86	4024052838110	3710-02.000

Axial

with male thread G3/4

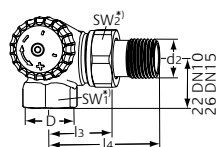
DN	d1	d2	l3	l4	H1	Kv p-band max. 2 K	Kvs	EAN	Article No
15	G3/4	R1/2	29	58	31,5	0,025 – 0,670	0,86	4024052840410	3730-02.000

Double angle

Connection to radiator left

DN	D	d2	l3	l4	Kv p-band max. 2 K	Kvs	EAN	Article No
10	Rp3/8	R3/8	26	52	0,025 – 0,670	0,86	4024052839018	3713-01.000
15	Rp1/2	R1/2	29	58	0,025 – 0,670	0,86	4024052839117	3713-02.000

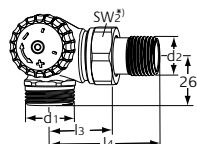
Double angle

with male thread G 3/4

Connection to radiator left

DN	d1	d2	l3	l4	Kv p-band max. 2 K	Kvs	EAN	Article No
15	G3/4	R1/2	29	58	0,025 – 0,670	0,86	4024052840519	3733-02.000

*) SW1: DN 10 = 22 mm, DN 15 = 27 mm, DN 20 = 32 mm

SW2: DN 10 = 27 mm, DN 15 = 30 mm, DN 20 = 37 mm

Values H1 and H2 are at the bearing surface thermostatic head or actuator.

 Kvs = m³/h at a pressure drop of 1 bar and fully open valve.

 Kv [xp] max. 2 K = m³/h at a pressure drop of 1 bar with thermostatic head.

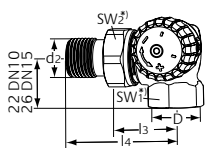

Double angle

Connection to radiator right

DN	D	d2	l3	l4	Kv p-band max. 2 K	Kvs	EAN	Article No
10	Rp3/8	R3/8	26	52	0,025 – 0,670	0,86	4024052839315	3714-01.000
15	Rp1/2	R1/2	29	58	0,025 – 0,670	0,86	4024052839414	3714-02.000

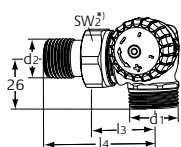

Double angle

with male thread G 3/4

Connection to radiator right

DN	d1	d2	l3	l4	Kv p-band max. 2 K	Kvs	EAN	Article No
15	G3/4	R1/2	29	58	0,025 – 0,670	0,86	4024052840618	3734-02.000

*) SW1: DN 10 = 22 mm, DN 15 = 27 mm, DN 20 = 32 mm

SW2: DN 10 = 27 mm, DN 15 = 30 mm, DN 20 = 37 mm

Values H1 and H2 are at the bearing surface thermostatic head or actuator.

Kvs = m³/h at a pressure drop of 1 bar and fully open valve.

Kv [xp] max. 2 K = m³/h at a pressure drop of 1 bar with thermostatic head.

Accessories



Setting key

For V-exact II from 2012.

EAN

Article No

4024052532216

4360-00.142

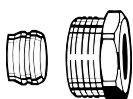

Compression fitting

for copper or precision steel pipe according to DIN EN 1057/10305-1/2.

Female thread connection

Rp 3/8 – Rp 3/4.

Metal-to-metal joint. Brass nickel-plated.

Support sleeves should be used for a pipe wall thickness of 0.8 – 1 mm. Follow the specifications of the pipe manufacturer.

Ø Pipe

DN

EAN

Article No

12 10 (3/8") 4024052174614 2201-12.351

14 15 (1/2") 4024052174713 2201-14.351

15 15 (1/2") 4024052175017 2201-15.351

16 15 (1/2") 4024052175116 2201-16.351

18 20 (3/4") 4024052175215 2201-18.351

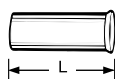

Support sleeve

for copper or precision steel pipe with a 1 mm wall thickness.

Brass.

Ø Pipe

L

EAN

Article No

12 25,0 4024052127016 1300-12.170

15 26,0 4024052127917 1300-15.170

16 26,3 4024052128419 1300-16.170

18 26,8 4024052128815 1300-18.170

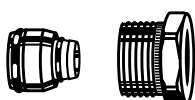

Compression fitting

for Alu/PEX multi-layer pipe according to DIN 16836.

Female thread connection Rp 1/2.

Nickel-plated brass.

Ø Pipe

EAN

Article No

16 x 2 4024052138616 1335-16.351

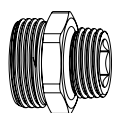

Double connection fitting

For clamping plastic, copper, precision steel or multi-layer pipes.
Brass, nickel-plated.

	L	EAN	Article No
G3/4 x R1/2	26	4024052308415	1321-12.083

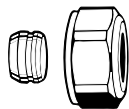

Compression fitting

for copper or precision steel pipe according to DIN EN 1057/10305-1/2. Connection male thread G 3/4 according to DIN EN 16313 (Eurocone). Metal-to-metal joint. Brass nickel-plated. With a pipe wall thickness of 0.8-1 mm insert supporting sleeves. Heed pipe manufacturer's technical advice.

Ø Pipe	EAN	Article No
12	4024052214211	3831-12.351
14	4024052214310	3831-14.351
15	4024052214617	3831-15.351
16	4024052214914	3831-16.351
18	4024052215218	3831-18.351

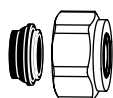

Compression fitting

for copper or precision steel pipe according to DIN EN 1057/10305-1/2. Connection male thread G 3/4 according to DIN EN 16313 (Eurocone). Soft sealed, max. 95°C. Nickel-plated brass.

Ø Pipe	EAN	Article No
15	4024052515851	1313-15.351
18	4024052516056	1313-18.351

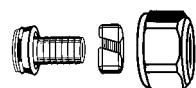

Compression fitting

for plastic pipe according to DIN 4726, ISO 10508.
PE-X: DIN 16892/16893, EN ISO 15875;
PB: DIN 16968/16969.
Connection male thread G 3/4 according to DIN EN 16313 (Eurocone).
Nickel plated brass.

Ø Pipe	EAN	Article No
12x1,1	4024052136018	1315-12.351
14x2	4024052134618	1311-14.351
16x1,5	4024052136117	1315-16.351
16x2	4024052134816	1311-16.351
17x2	4024052134915	1311-17.351
18x2	4024052135110	1311-18.351
20x2	4024052135318	1311-20.351



Compression fitting

for Alu/PEX multi-layer pipe according to DIN 16836.
Connection male thread G 3/4 according to DIN EN 16313 (Eurocone).
Nickel-plated brass.

Ø Pipe	EAN	Article No
16x2	4024052137312	1331-16.351
18x2	4024052137411	1331-18.351

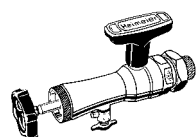

Fitting tool

complete with case, box spanner and replacement seals, for replacing thermostatic inserts without draining off the heating system (for DN 10 to DN 20).

	EAN	Article No
Fitting tool	4024052298914	9721-00.000
Replacement seals	4024052299010	9721-00.514

Other accessories, see catalogue leaflet "Accessories and spare parts for thermostatic radiator valves".