

# INSTALLATION INSTRUCTIONS

## NE6422B

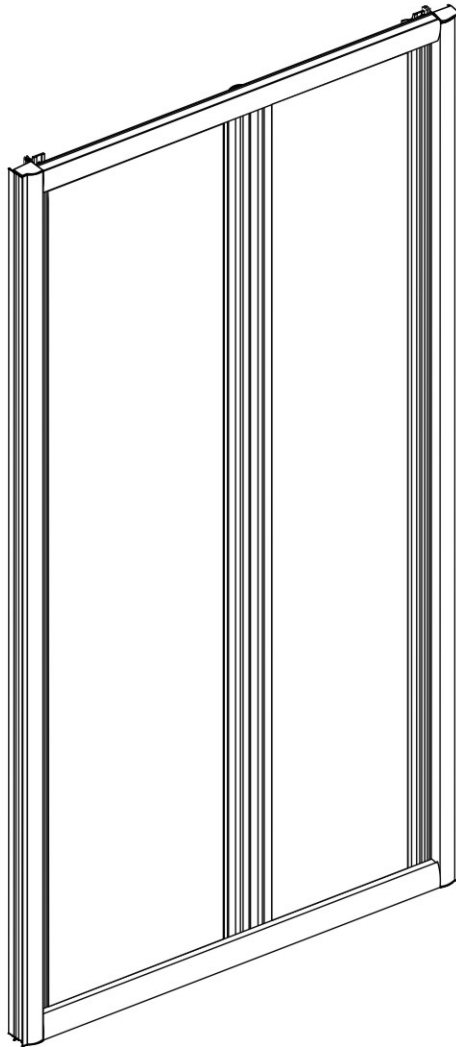

Size: 700x1900mm  
800x1900mm  
900x1900mm



## ◆ General Information

Please inspect the product immediately upon receipt for transit damage, missing packs/parts or manufacturing fault. Damage reported later cannot be accepted. Please handle the product with care avoiding knocks and shock loading to all sides and edges of the glass.

### **Notes: Safety glass can not be re-worked.**

Please read these instructions carefully before start of installation.

Special care should be taken when drilling walls to avoid hidden pipes or electrical cables.

Note: This product is heavy and may require two people to install.

## **Aftercare instructions**

After use, your shower should be cleaned with soap and water. This is particularly important in hard water districts where insoluble lime salts may be deposited and allowed to build up.

Cleaners of a gritty or abrasive nature should not be used. Care should be taken to avoid contact with strong chemicals such as organic solvents and strippers.

Glass cleaners can be used but with caution, if in doubt contact the manufacturer of the cleaner in question.

Please keep these instructions for aftercare and customer service details.

---



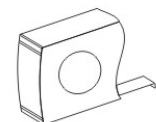
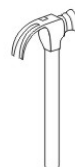
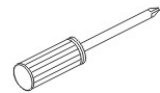
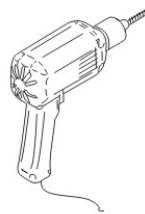
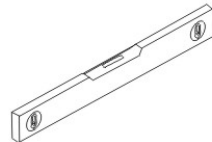
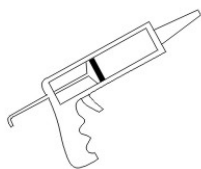

## **Tools Required**



**This product is heavy and may require two people to install.**

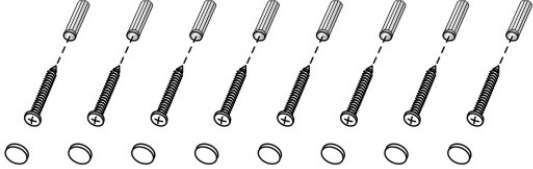
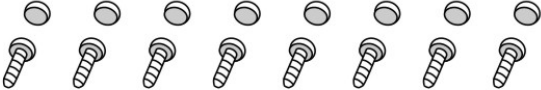

## ◆ Box Contents:

<p>[1] 1xInstallation Instruction</p>	→	
<p>[2] 8xWall Plugs 8xScrews M4x35 8xScrew Cover Caps</p>	→	
<p>[3] 8xScrews M4x8 8xScrew Cover Caps</p>	→	
<p>[4] 4xProfile Covers</p>	→	
<p>[5] 2xWall Posts</p>	→	
<p>[6] 2xDoor Panels</p>	→	

# ◆ Assembly Drawing

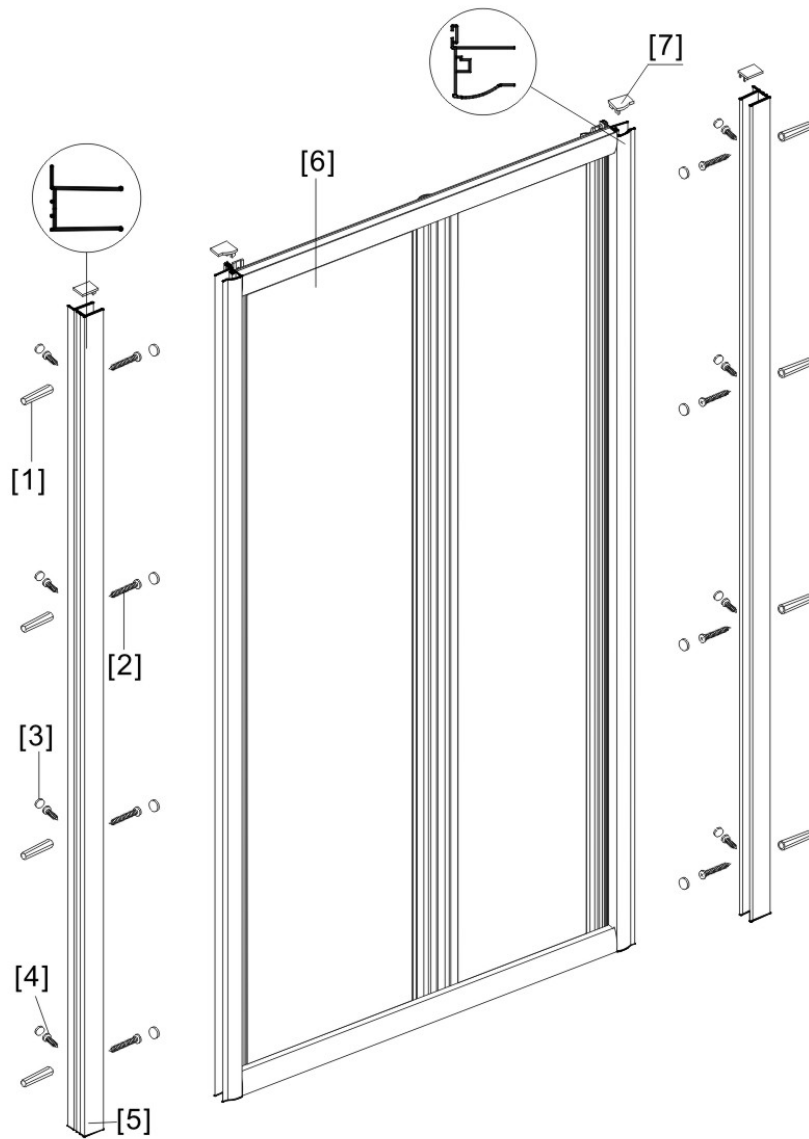

- [1] 8xWall Plugs
- [2] 8xScrews M4x35
- [3] 16xScrew Cover Caps

- [4] 8xScrews M4x8
- [5] 2xWall Posts
- [6] 2xDoor Panels
- [7] 4xProfile Covers

# ◆ Extension Drawing For Door Panel

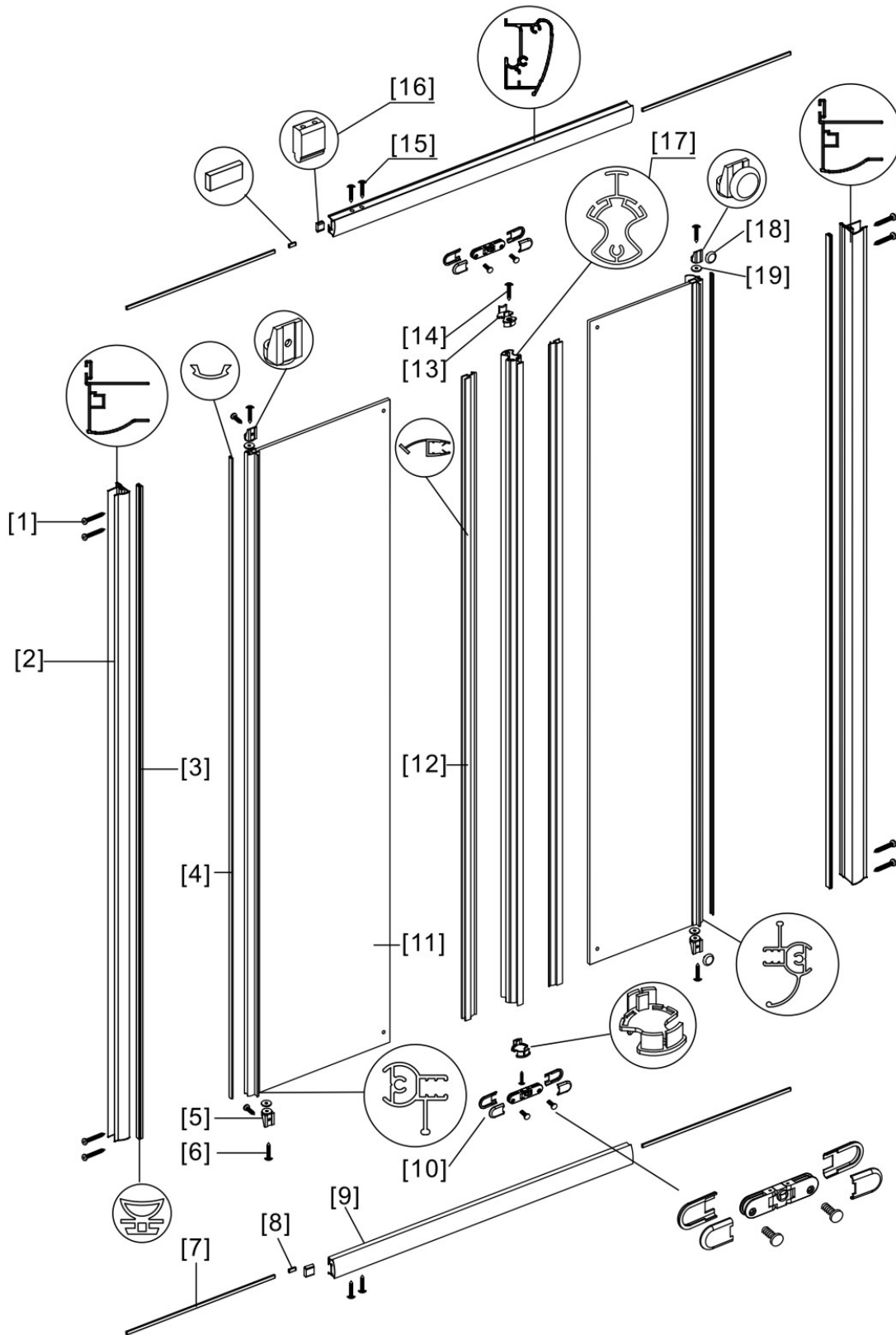

- [1] 8x Flat Screws M4x35
- [2] 2x Posts
- [3] 2x Soft Gaskets
- [4] 2x Hand Gaskets
- [5] 4x Wheel Plates
- [6] 4x Screws M4x25
- [7] 4x Square Gaskets
- [8] 2x Square Magnets
- [9] 2x Horizontal Rails
- [10] 2x Folders

- [11] 2x Glass Panels
- [12] 2x Deflectors
- [13] 2x Profile Covers
- [14] 2x Screws M4x25
- [15] 6x Screws M4x14
- [16] 2x Plastic Blocks
- [17] 1x Post
- [18] 2x Rollers
- [19] 4x Brass Gaskets

# ◆ Installation Steps

## Step 1

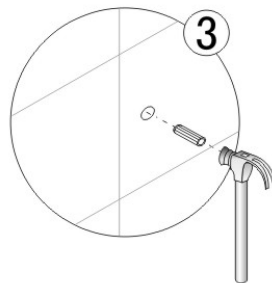
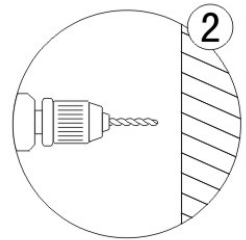
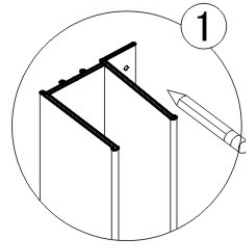
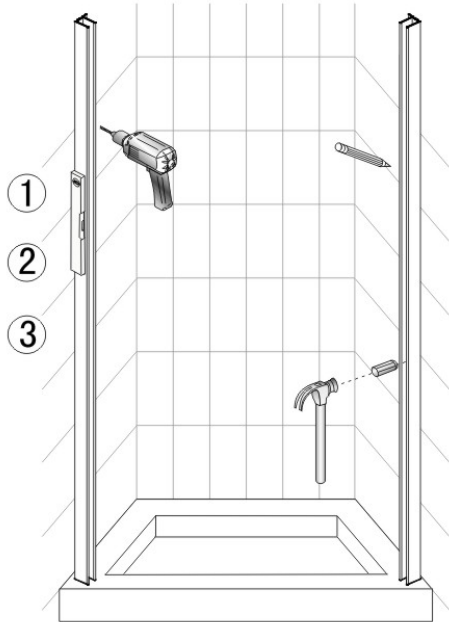

## Step 2

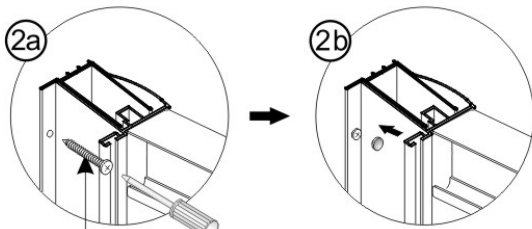
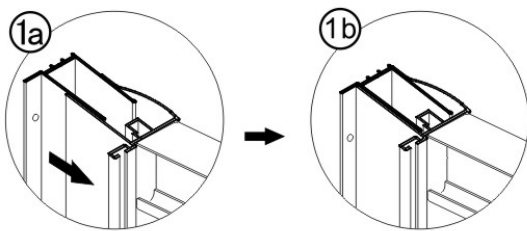

Screw M4x35

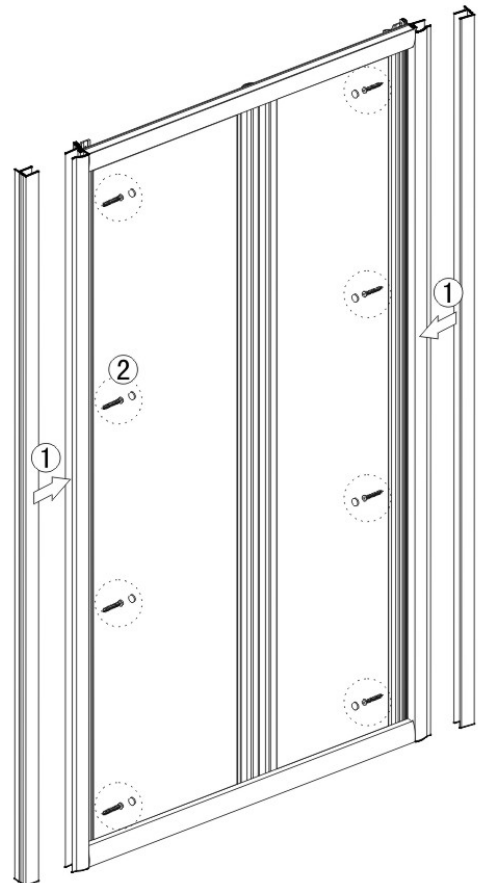

⚠ Ensure wall profiles are plumb.  
Adjust enclosure to be square and level.  
Wheels should be adjusted to square the  
doors and ensure smooth running.

### Step 3

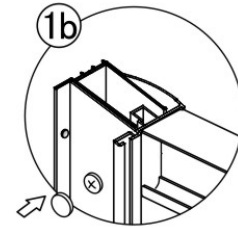
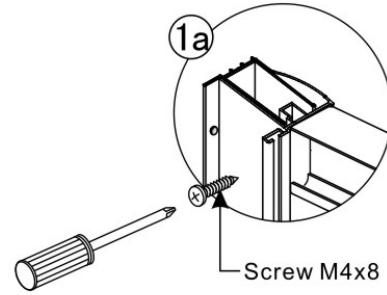
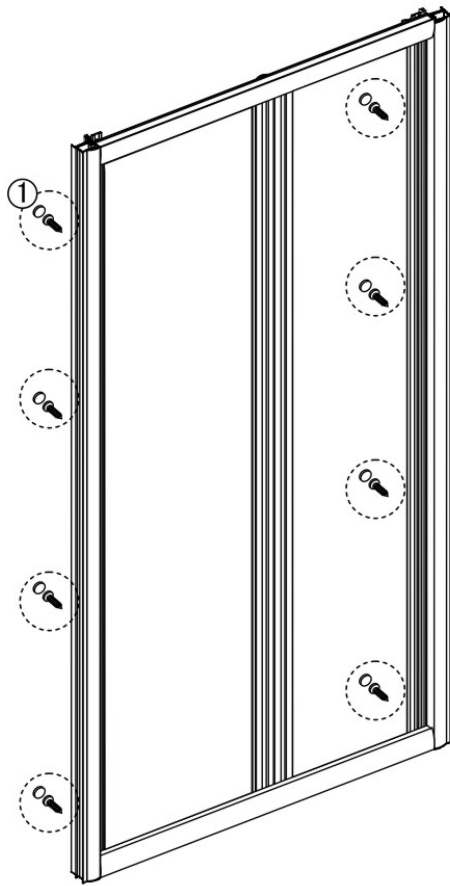

View from inside

### Step 4

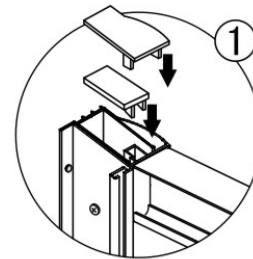
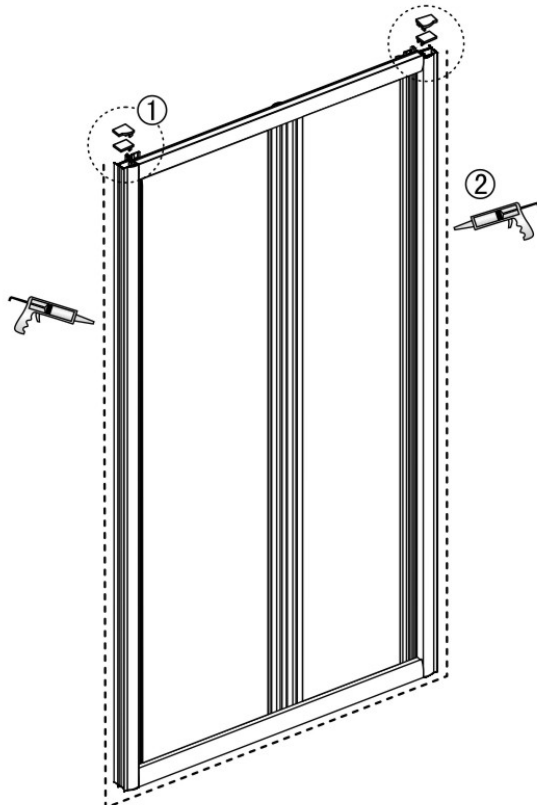

Allow 24 hours for silicone to dry before use.