

INSTALLATIE VOORSCHRIFT

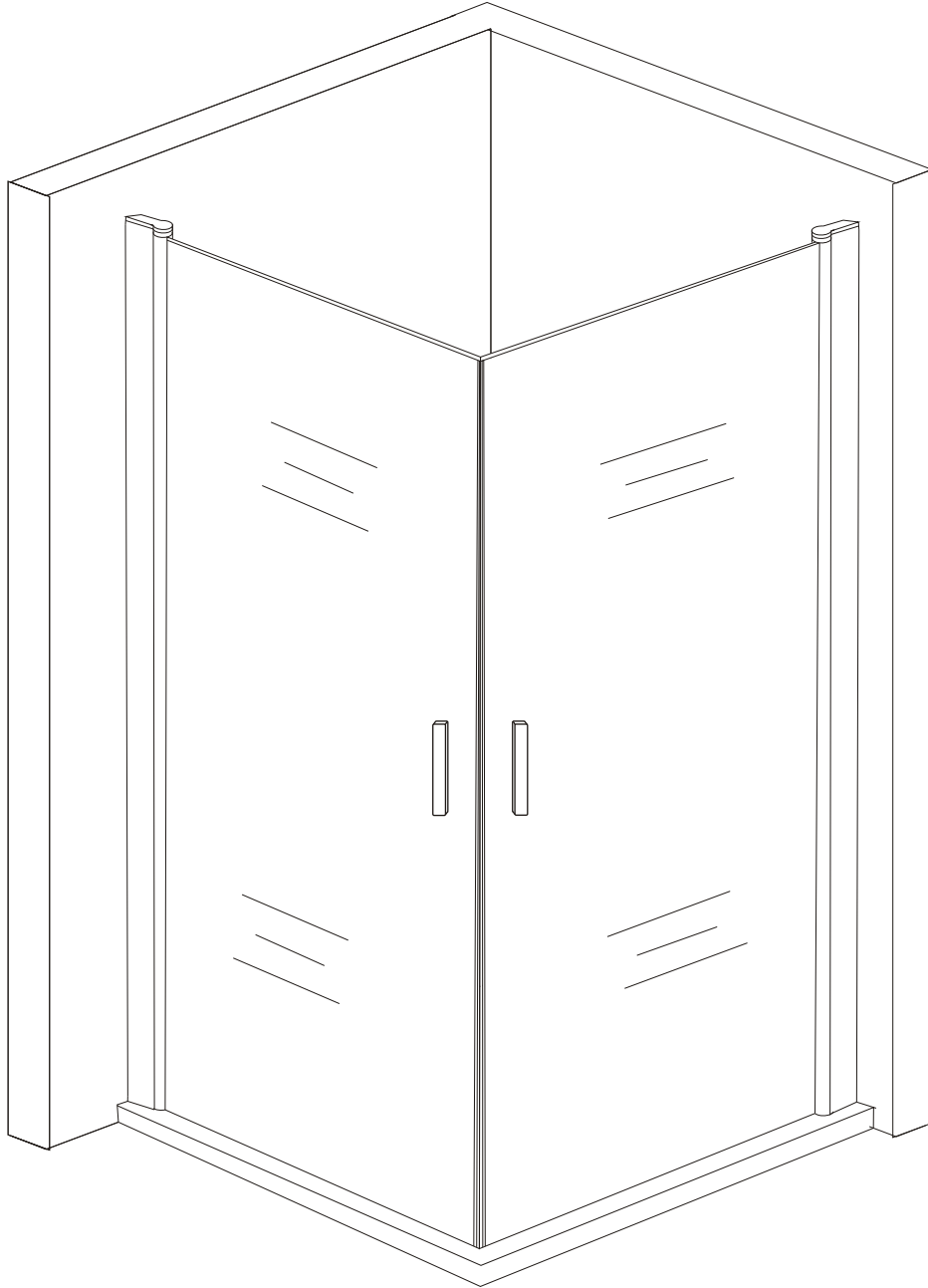

Dubbele swingdeuren met NANO behandeld glas

20.3845

RoHS  **ISO9001:2000**

GEREEDSCHAP

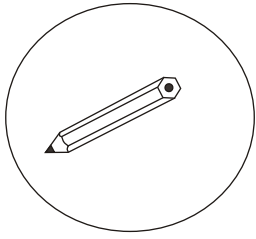

Pencil

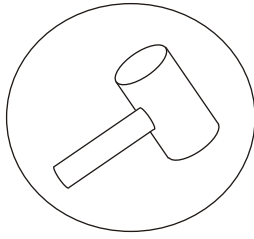

Rubberen hamer

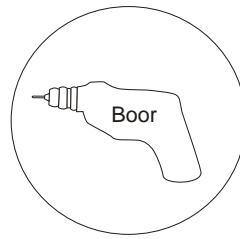

Boormachine

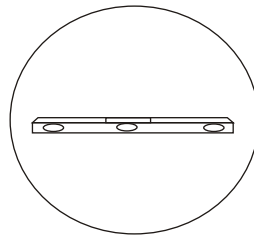

Waterpas

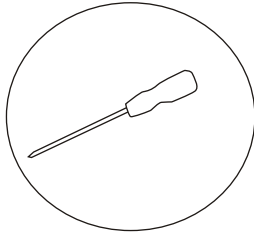

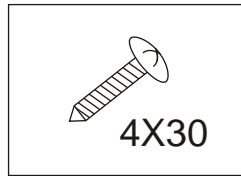
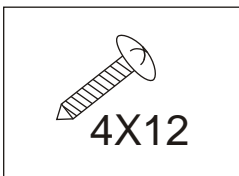
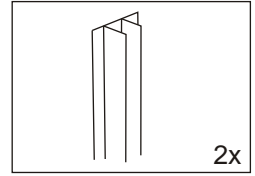
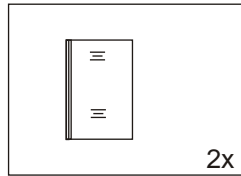
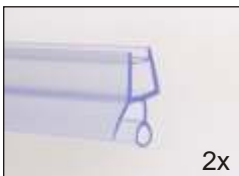

Kruisschroevendraaier

Inhoud van de verpakking:

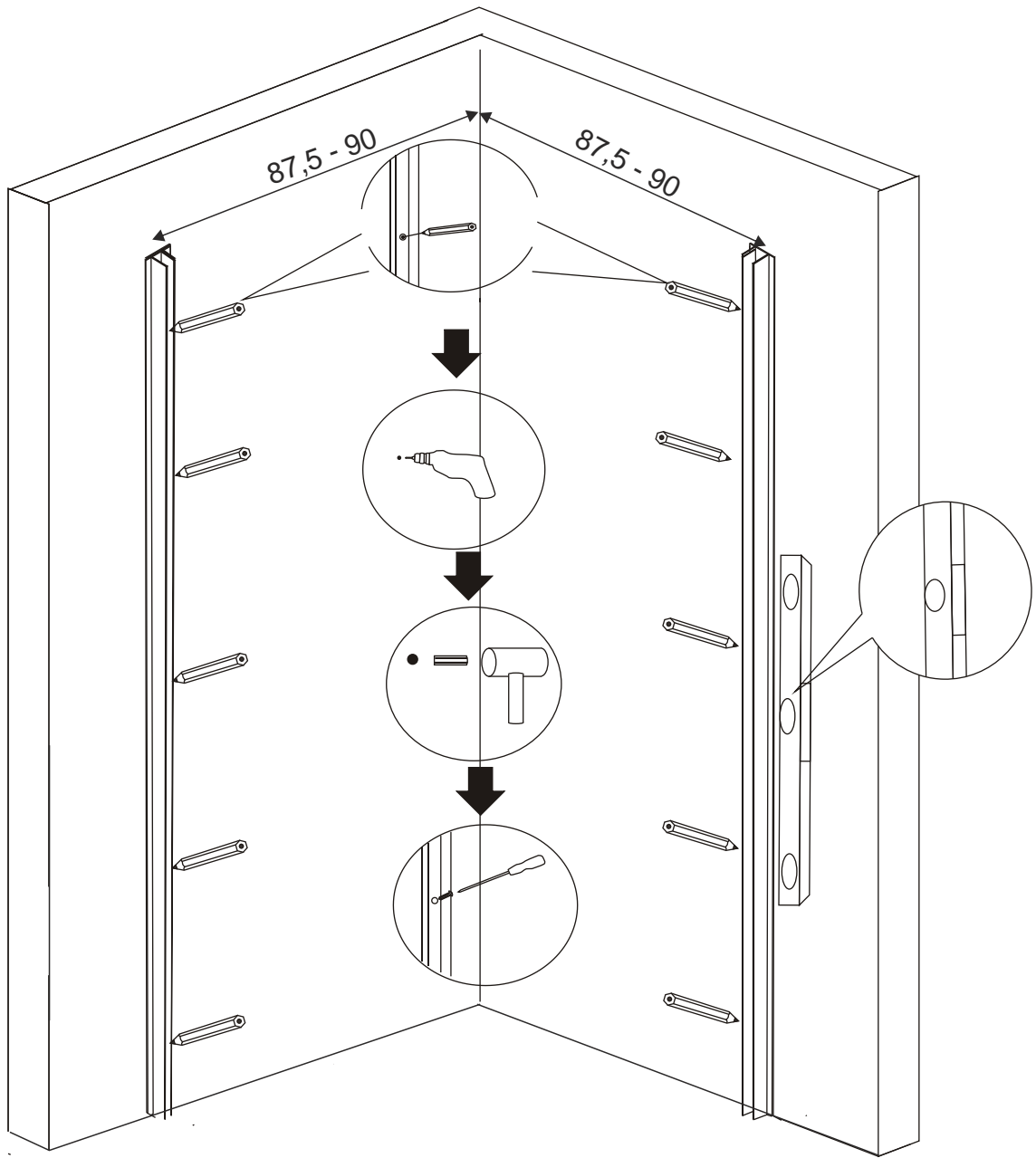
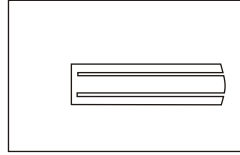
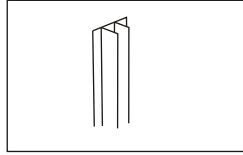
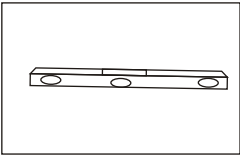
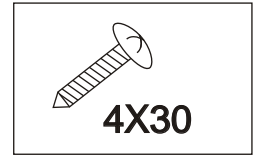
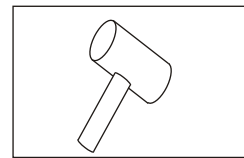
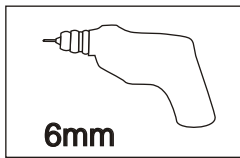
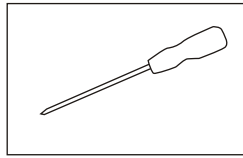
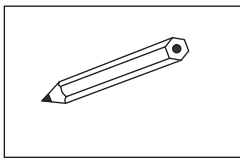

1. Houdt het aluminium profiel waterpas tegen de muur op minimaal 87,50 en maximaal 90cm (hart-op-hart)
2. Zorg dat beide profielen exact even hoog geplaatst worden.
3. Gebruik een potlood om de gaten af te tekenen.
4. Gebruik een 6mm boortje om de gaten te maken
5. De pluggen in de gaten en het profiel vastschroeven.



Opmerking: U moet er voor zorgen dat de NANO zijde altijd aan de binnenzijde zit. De NANO zijde is te herkennen aan dit  label.

1. Voorzie de deur met de kunststof waterkering
2. plaats één van de glazen deur in het profiel.

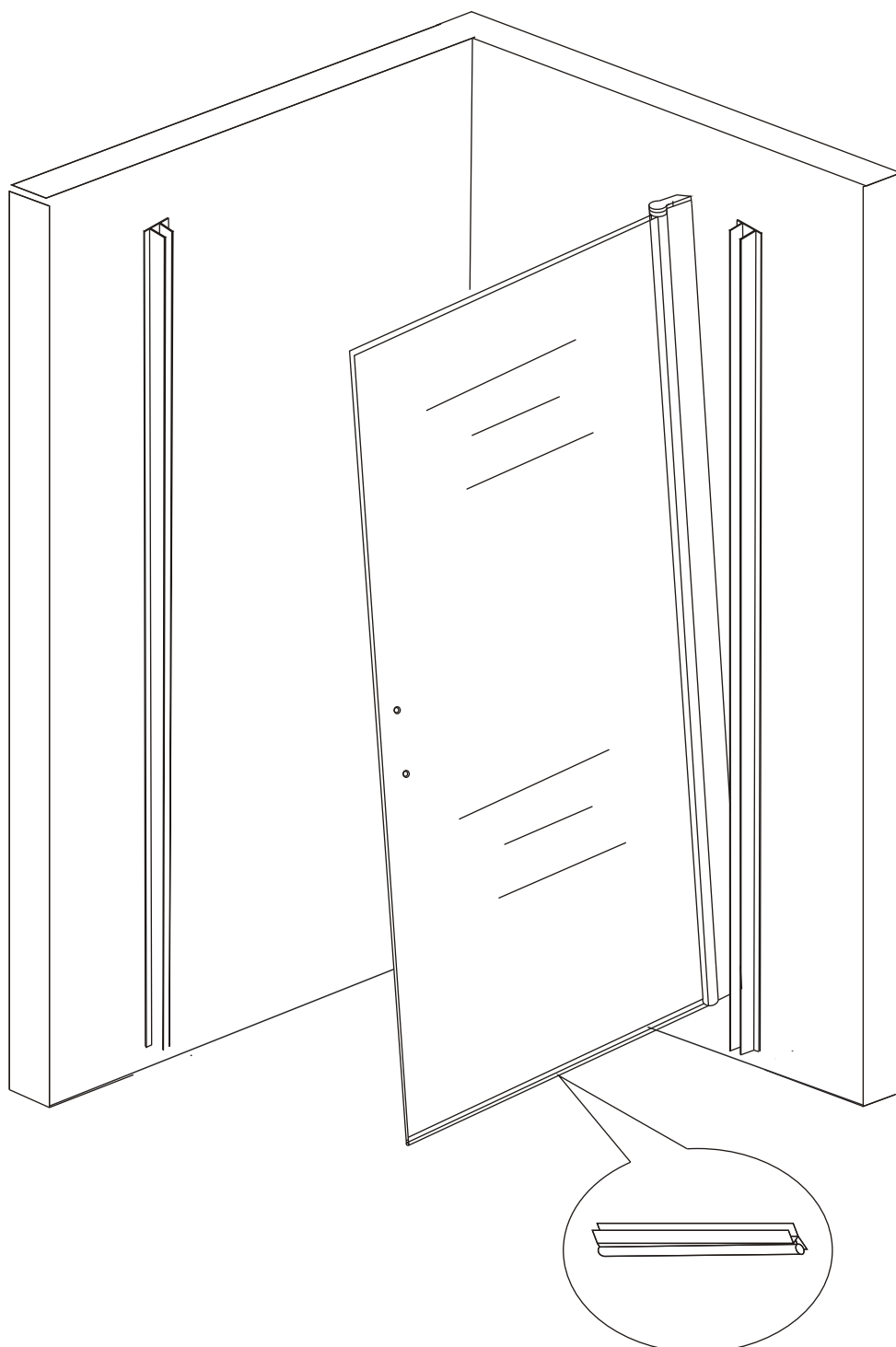
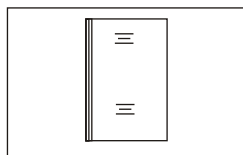

1. Plaats de andere deur, voorzien van de kunststof waterkering in het muurprofiel
2. Gebruik siliconenkit om de magnetische strip op beide deuren te monteren

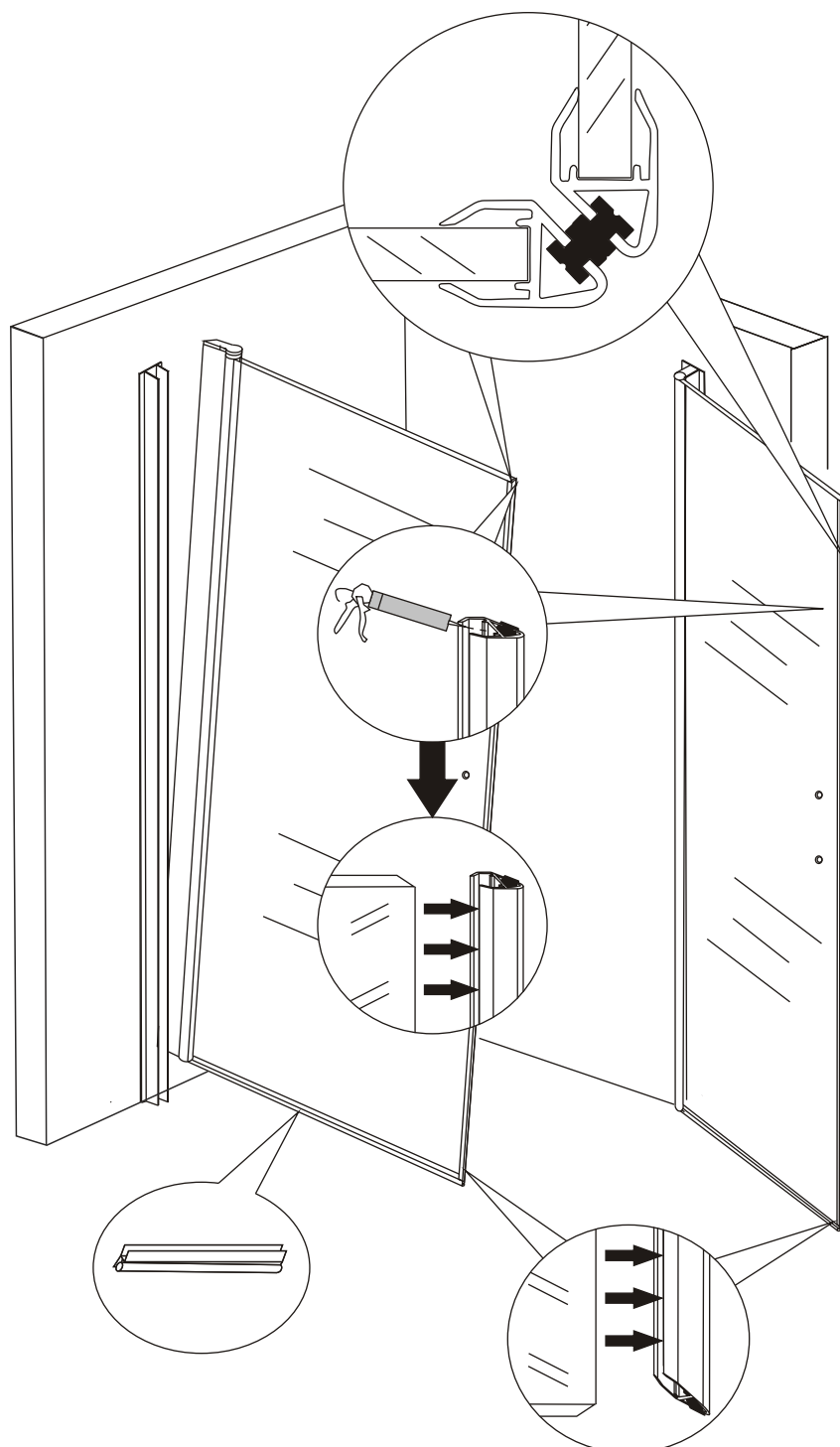
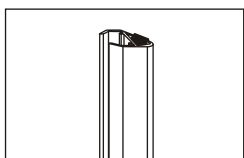
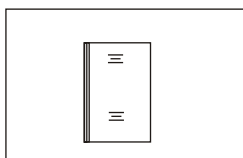

1. Boor met een 3mm boortje 4 gaatjes in ieder profiel en schroef de deuren vast.
2. Monteer de handgrepen.

