

1x

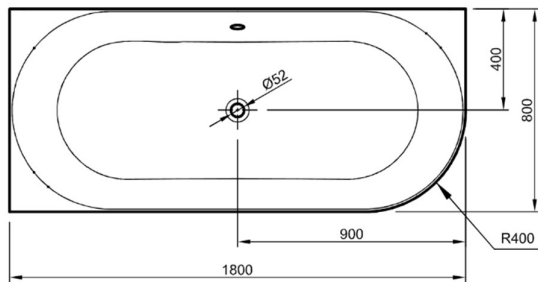

8x

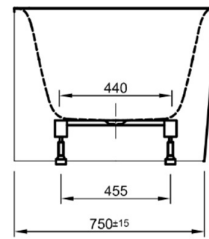
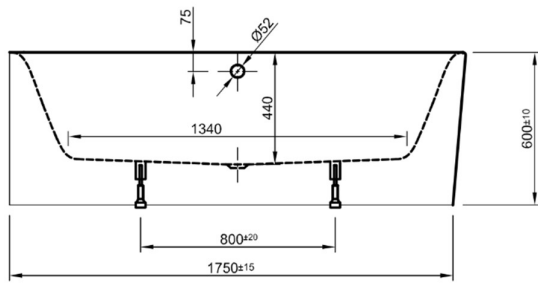

8x



4x

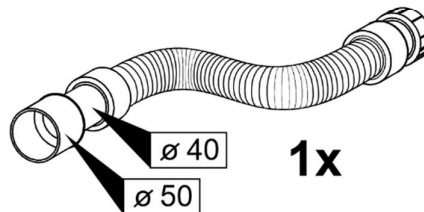
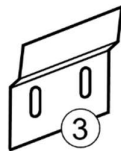

Fig. 1

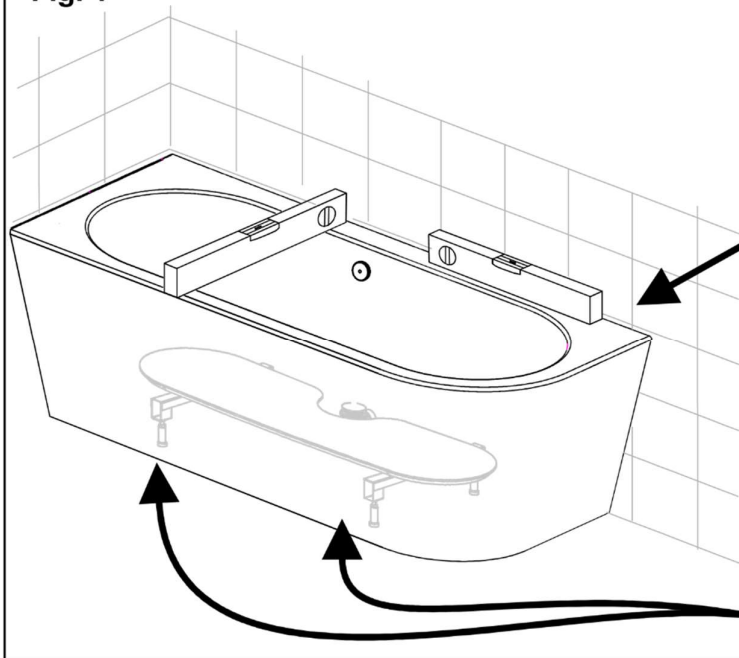

Fig. 3

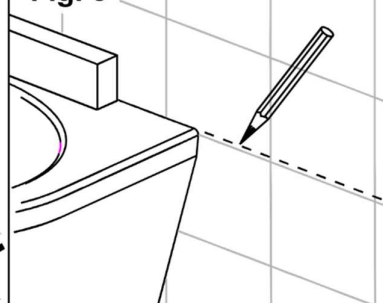

Fig. 2

