

# DSPSC0700+ - Side panel 700mm

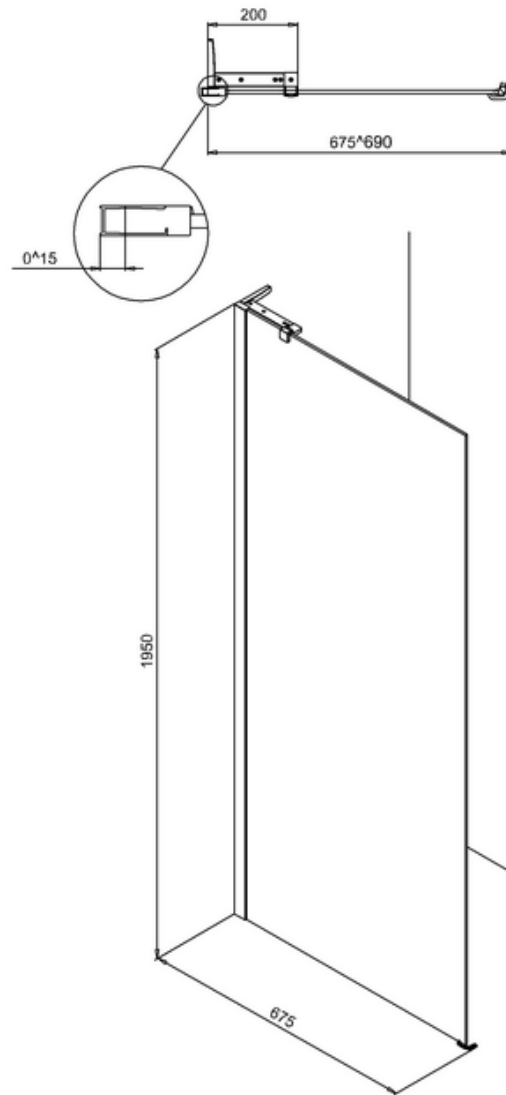

Note:  
Whole dimension tolerance is  $\pm 5$ .  
Glass dimension tolerance is  $\pm 2$ .