

## 3E bediening van rechts naar links ombouwen

1

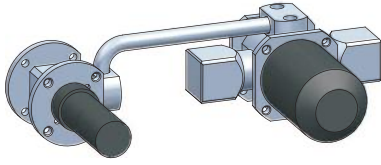

2

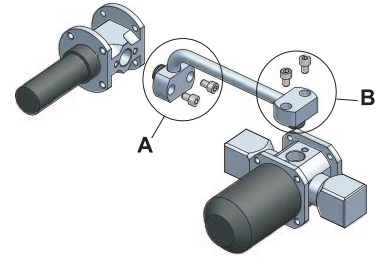

3

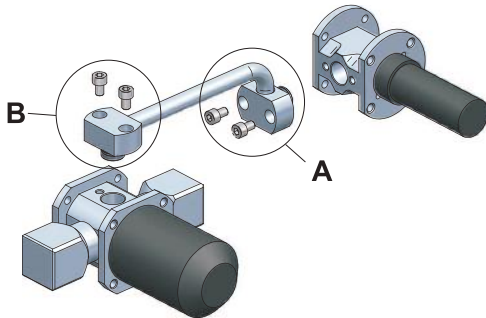

4

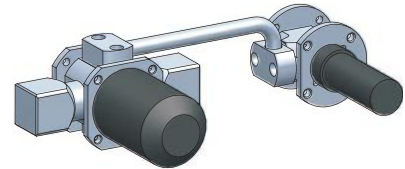

## 3E bediening van rechts naar boven ombouwen

1

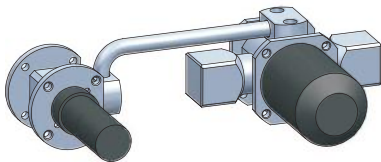

2

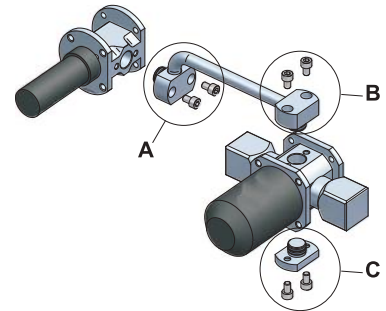

3

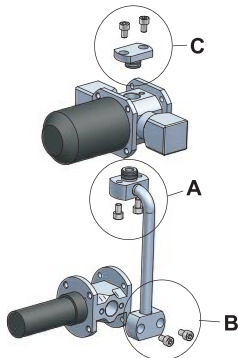

4

