

EFF2

■ GEBERIT

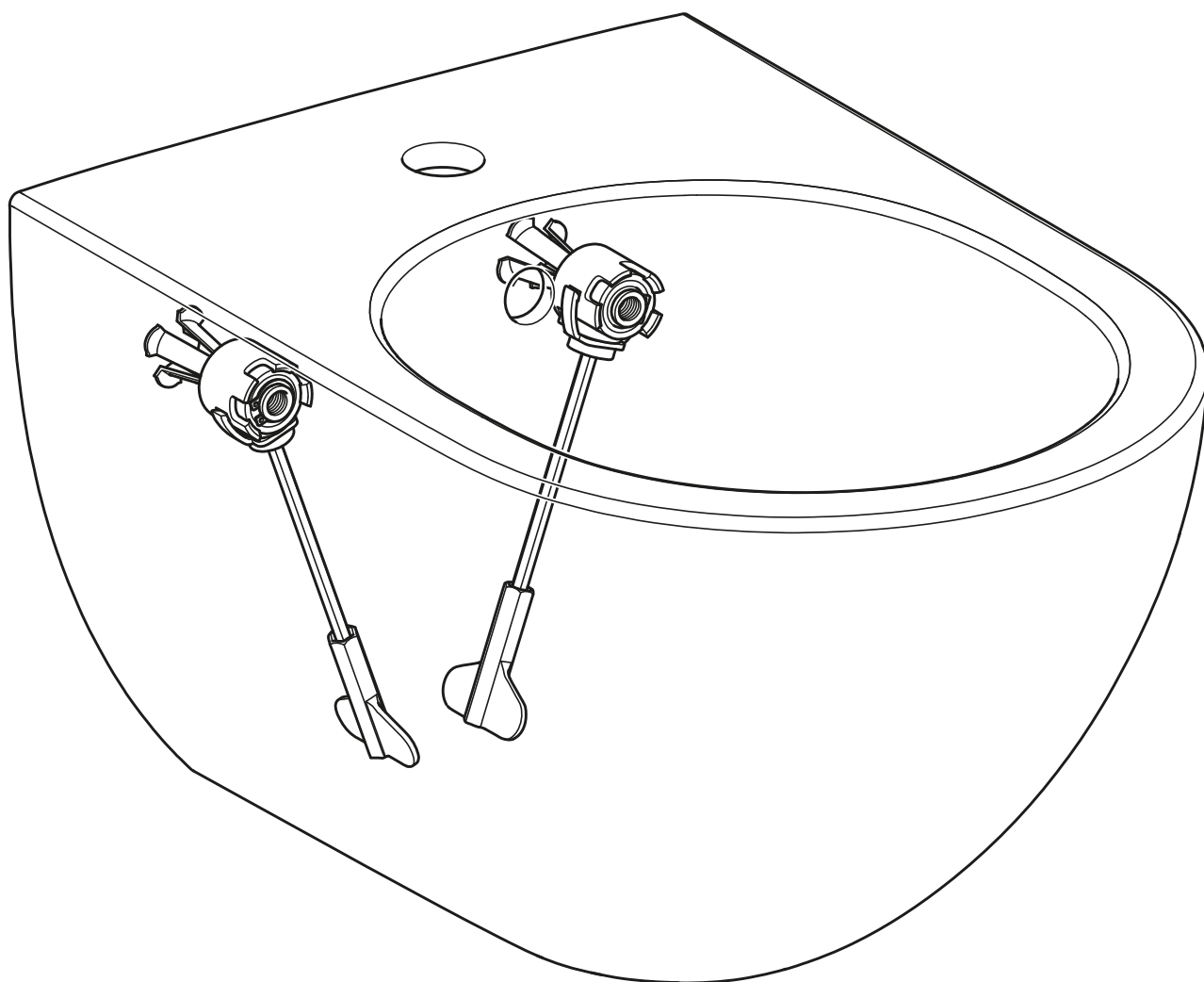

# INSTALLATION MANUAL

MONTAGEANLEITUNG  
INSTRUCTIONS DE MONTAGE  
ISTRUZIONI PER IL MONTAGGIO

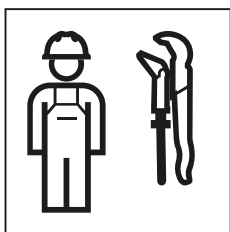



1

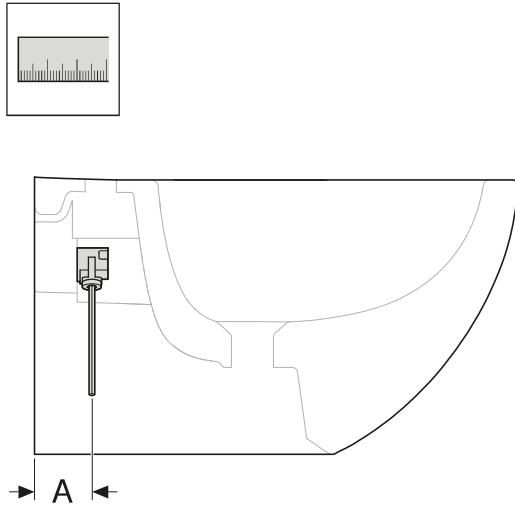

2

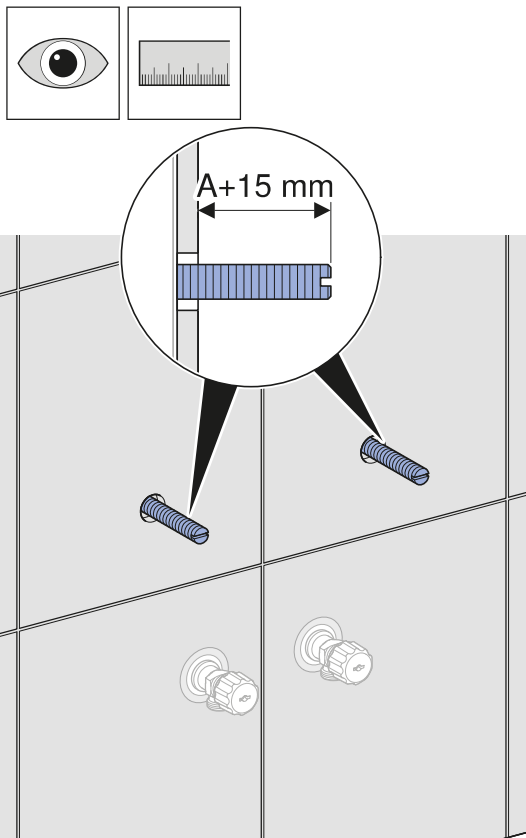

3

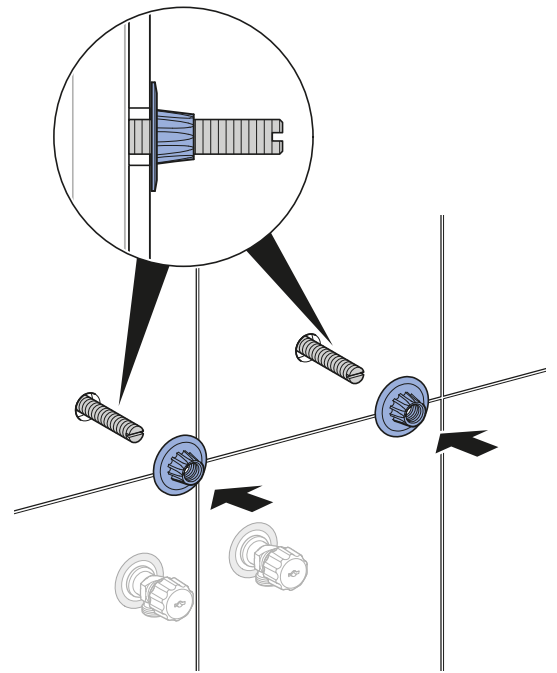

4

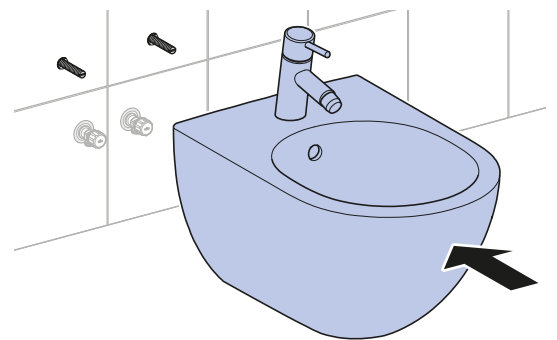

5

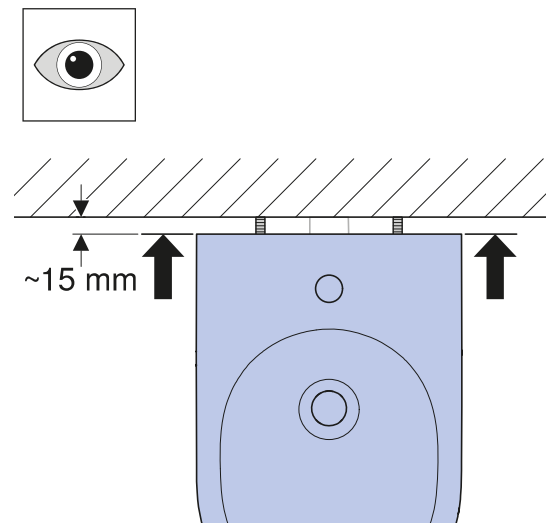

6

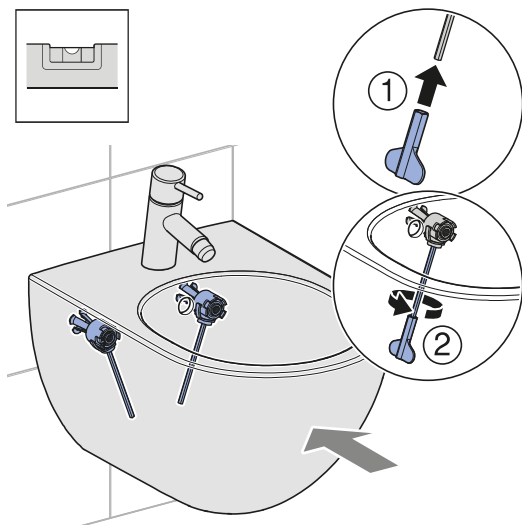



---

**Geberit International AG**  
Schachenstrasse 77, CH-8645 Jona  
documentation@geberit.com  
www.geberit.com