

Installation

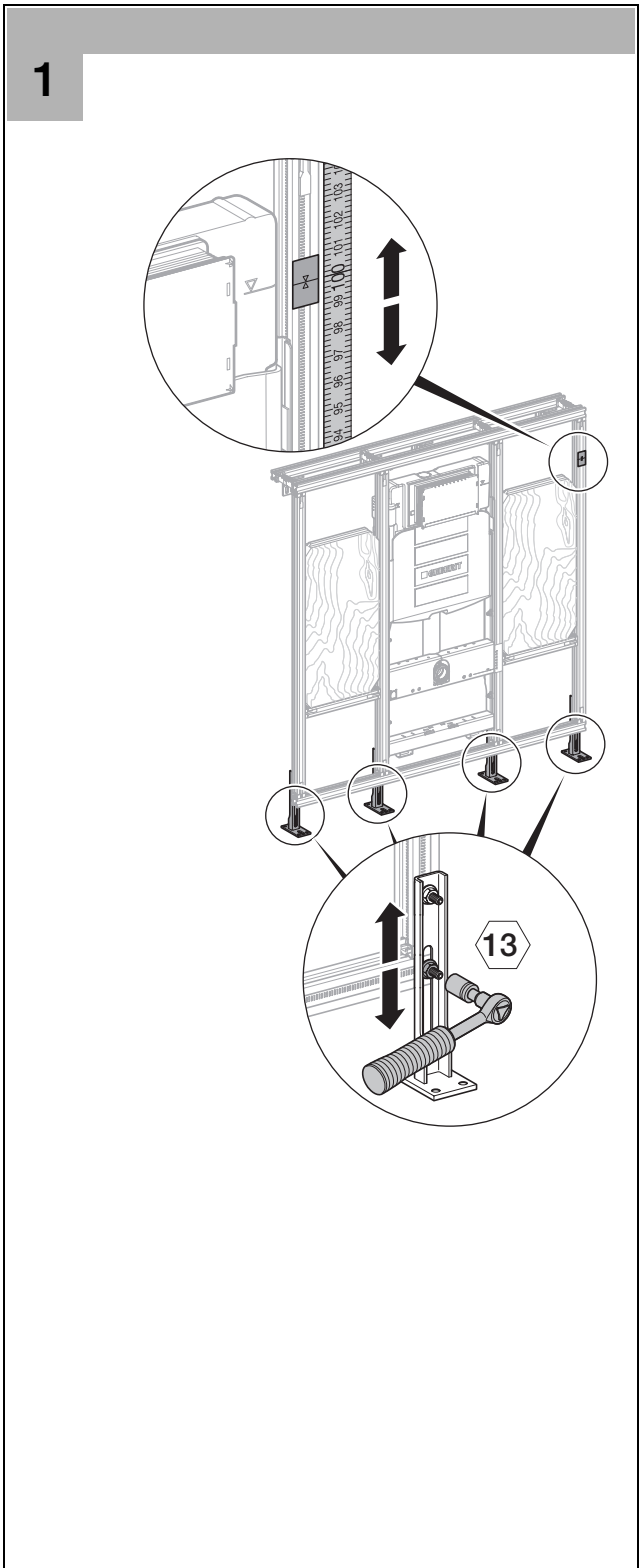

D25628-001&BDC © 02-2008

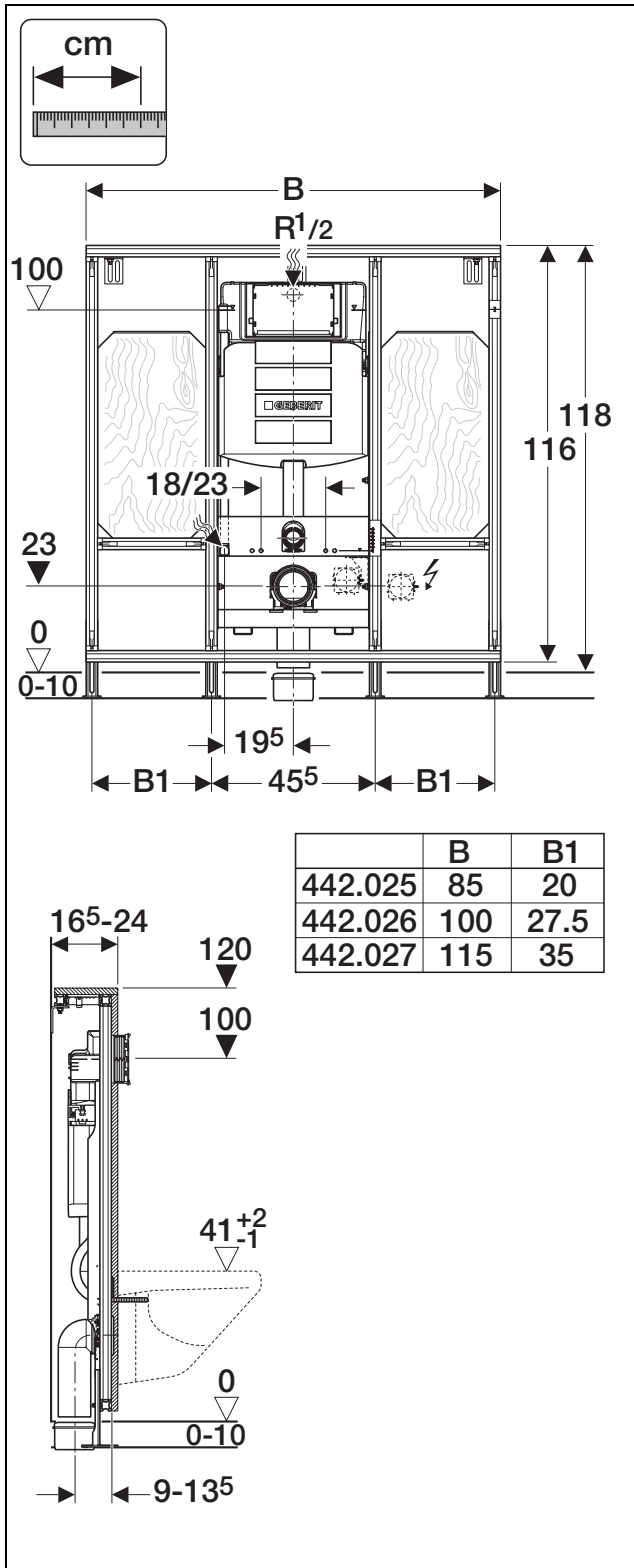

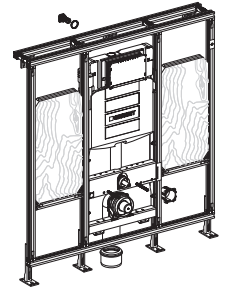
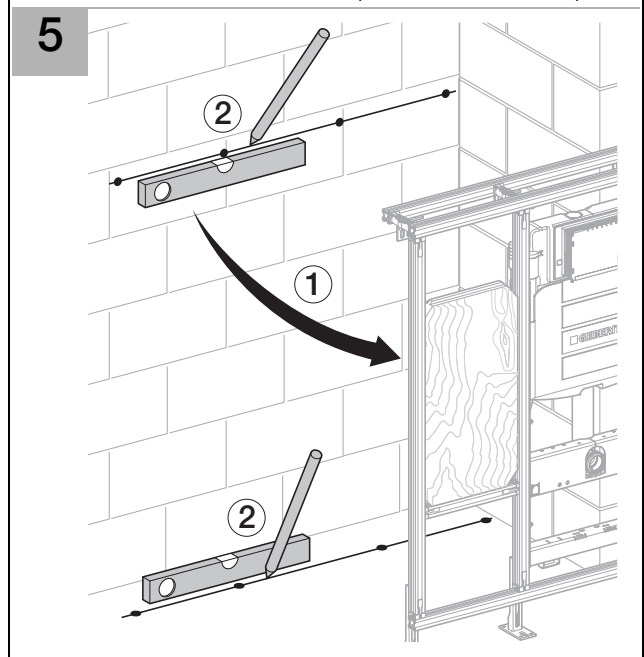
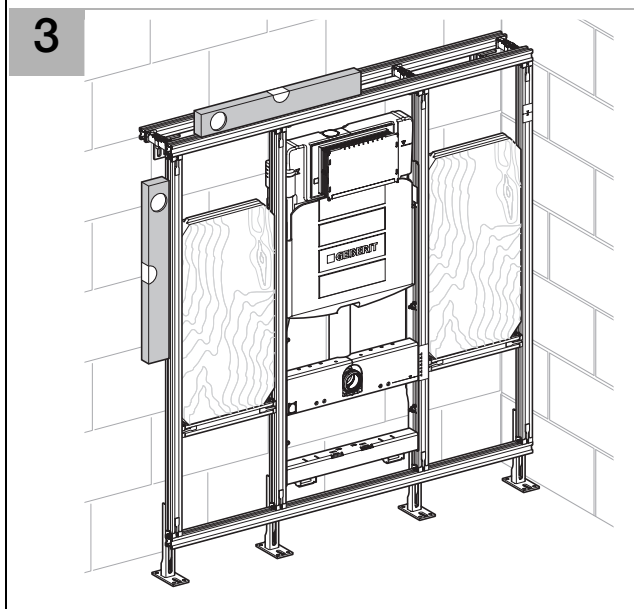
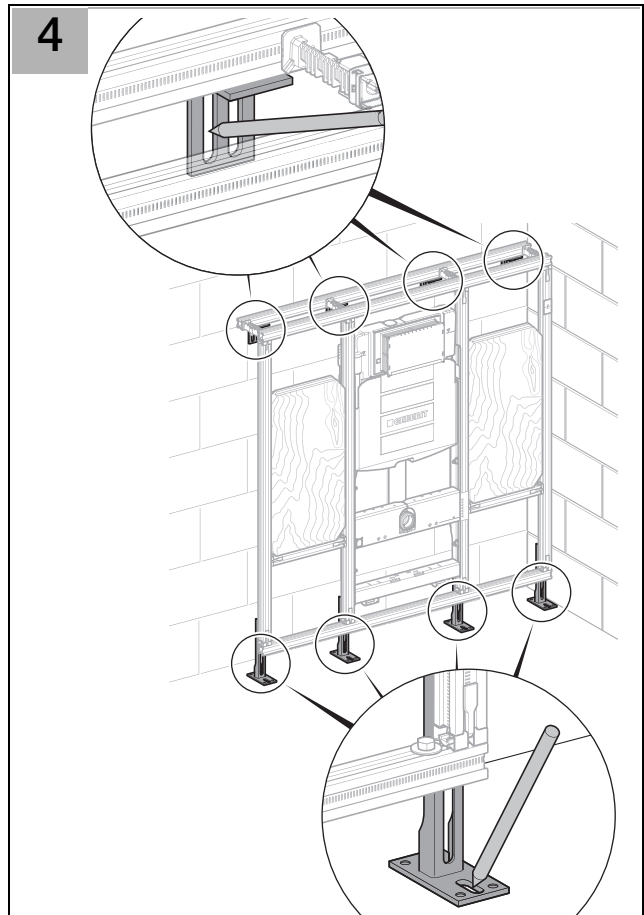
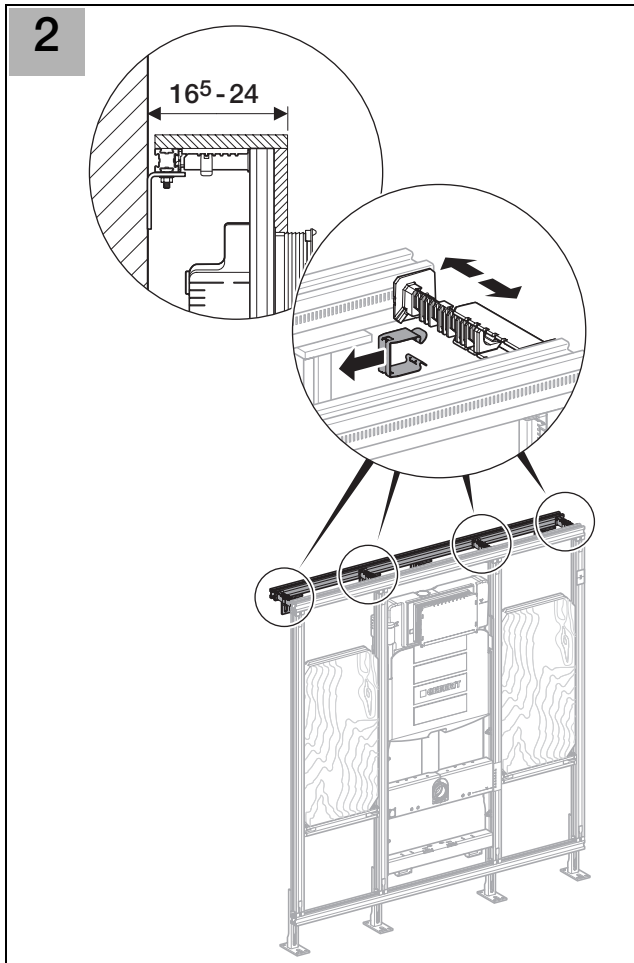
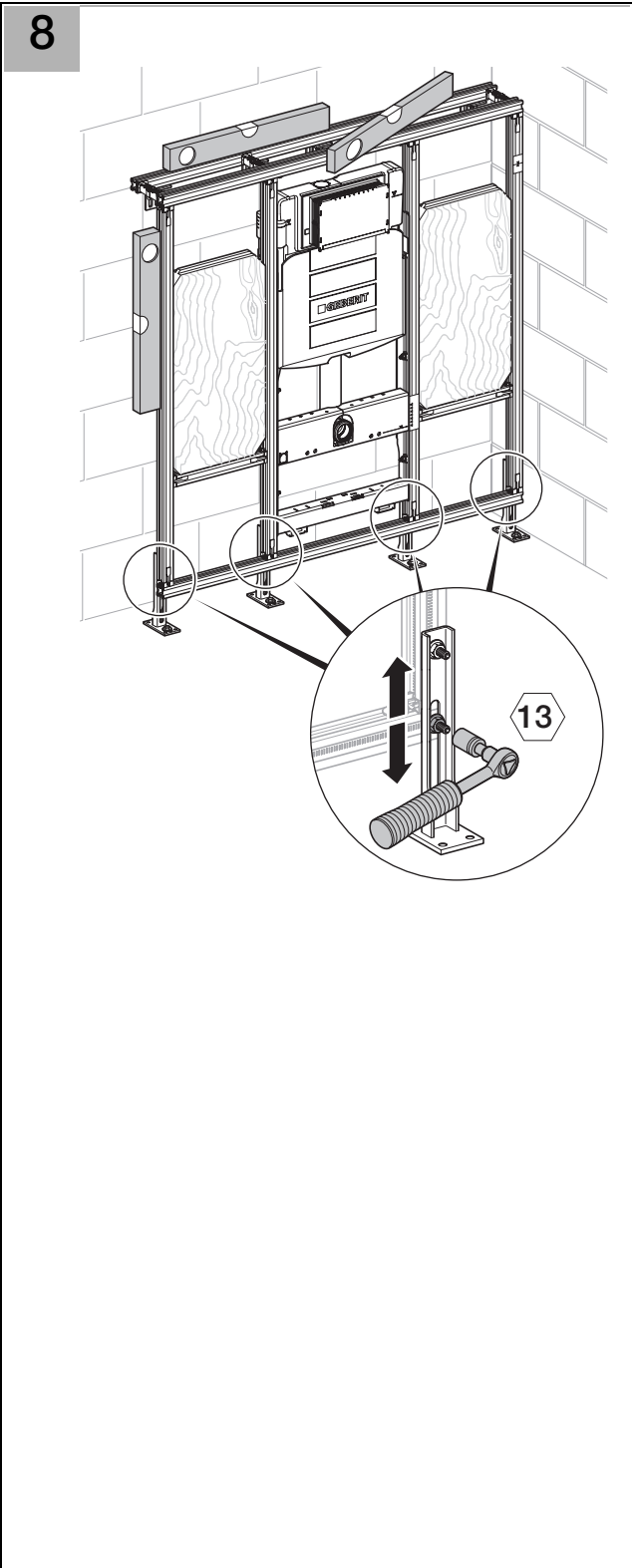
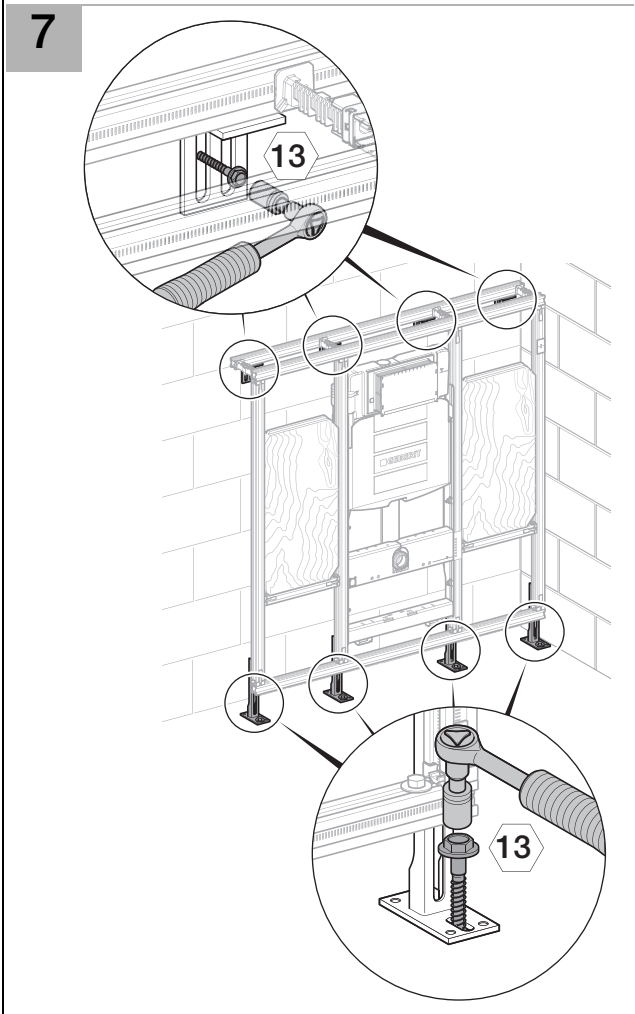
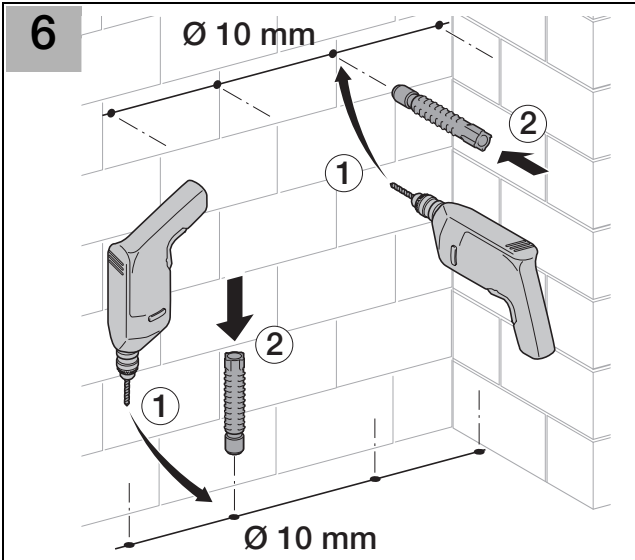

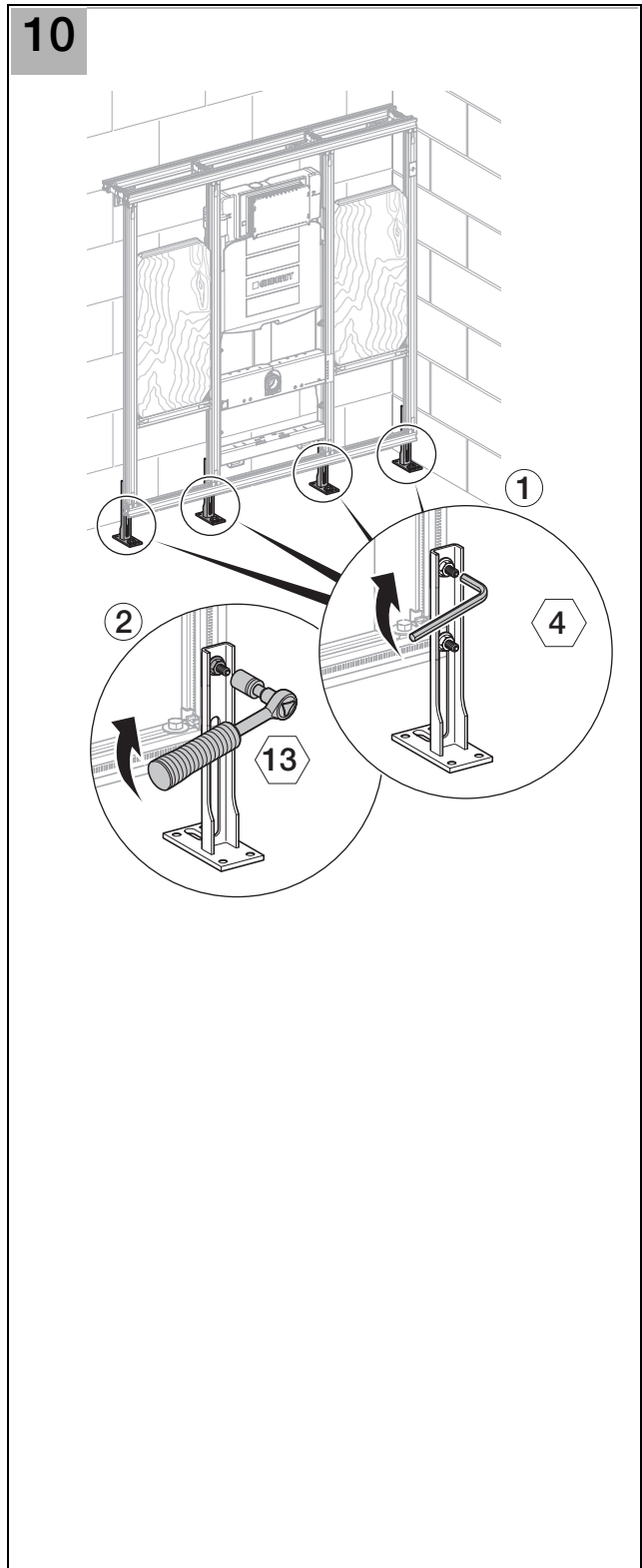
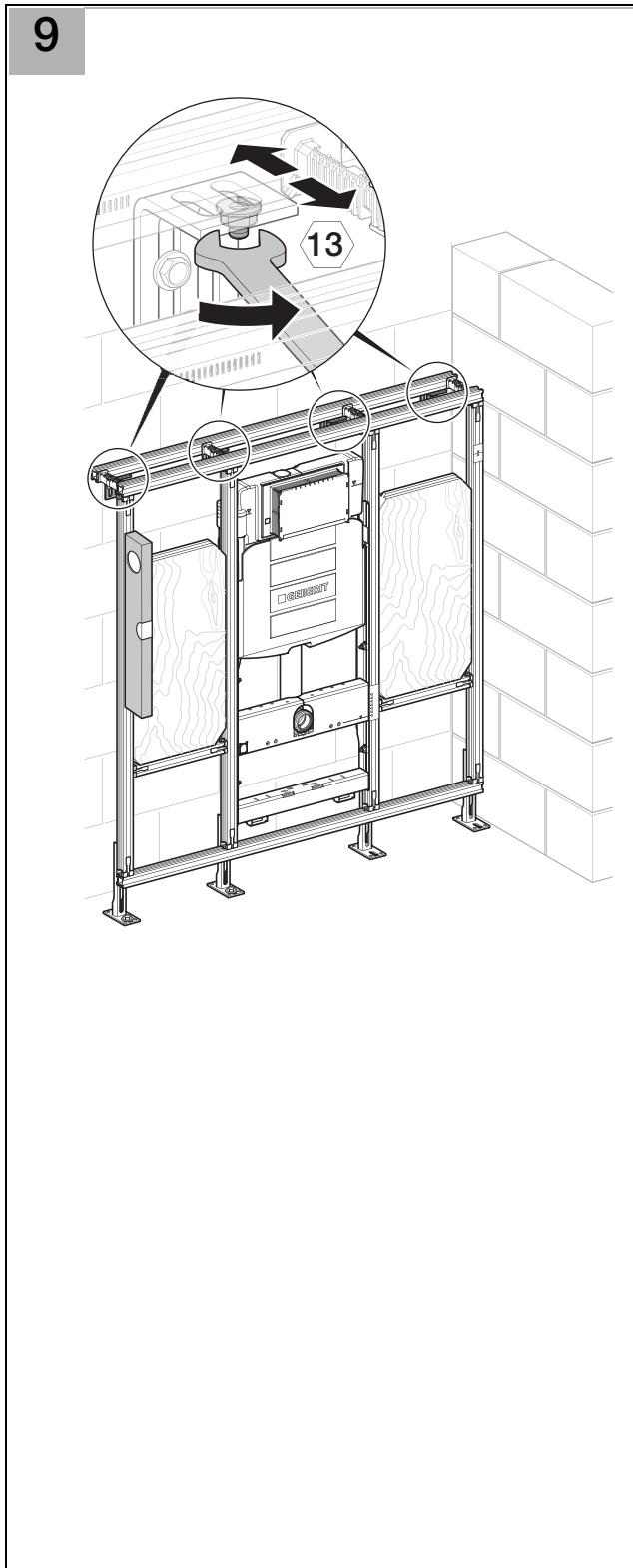

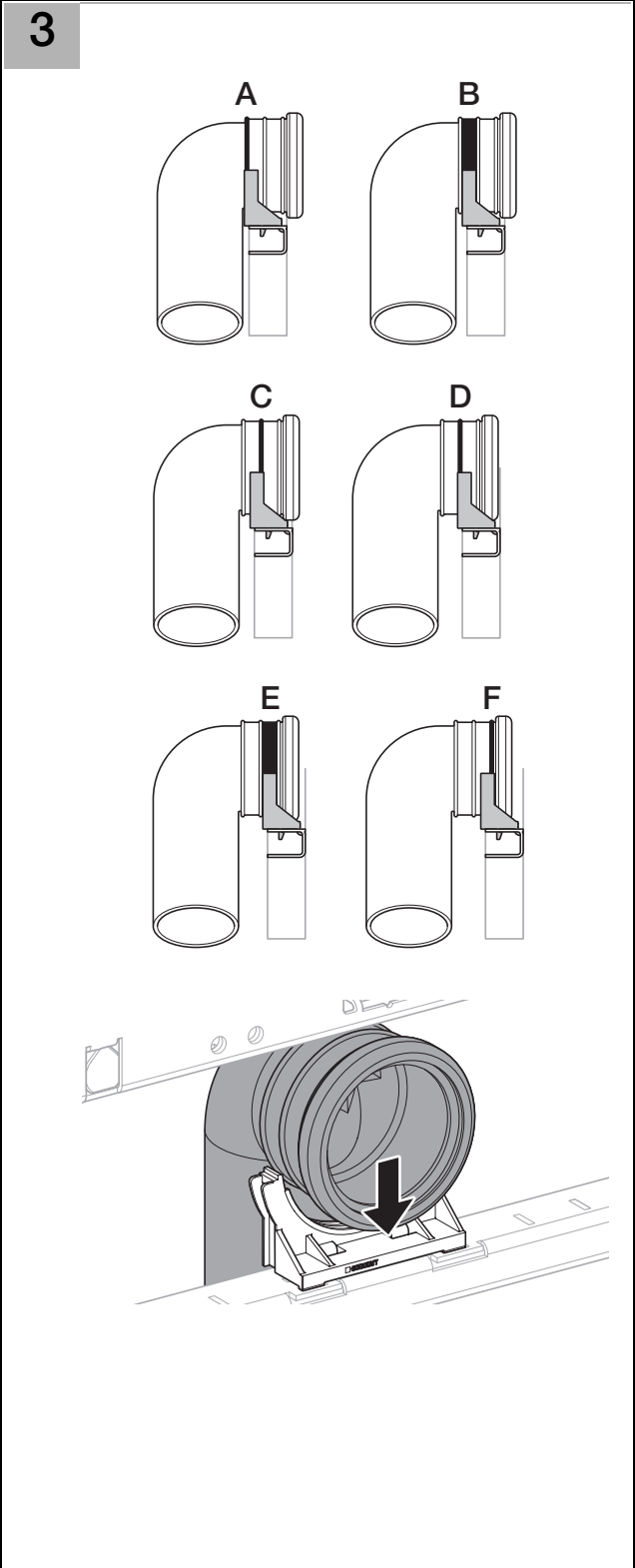
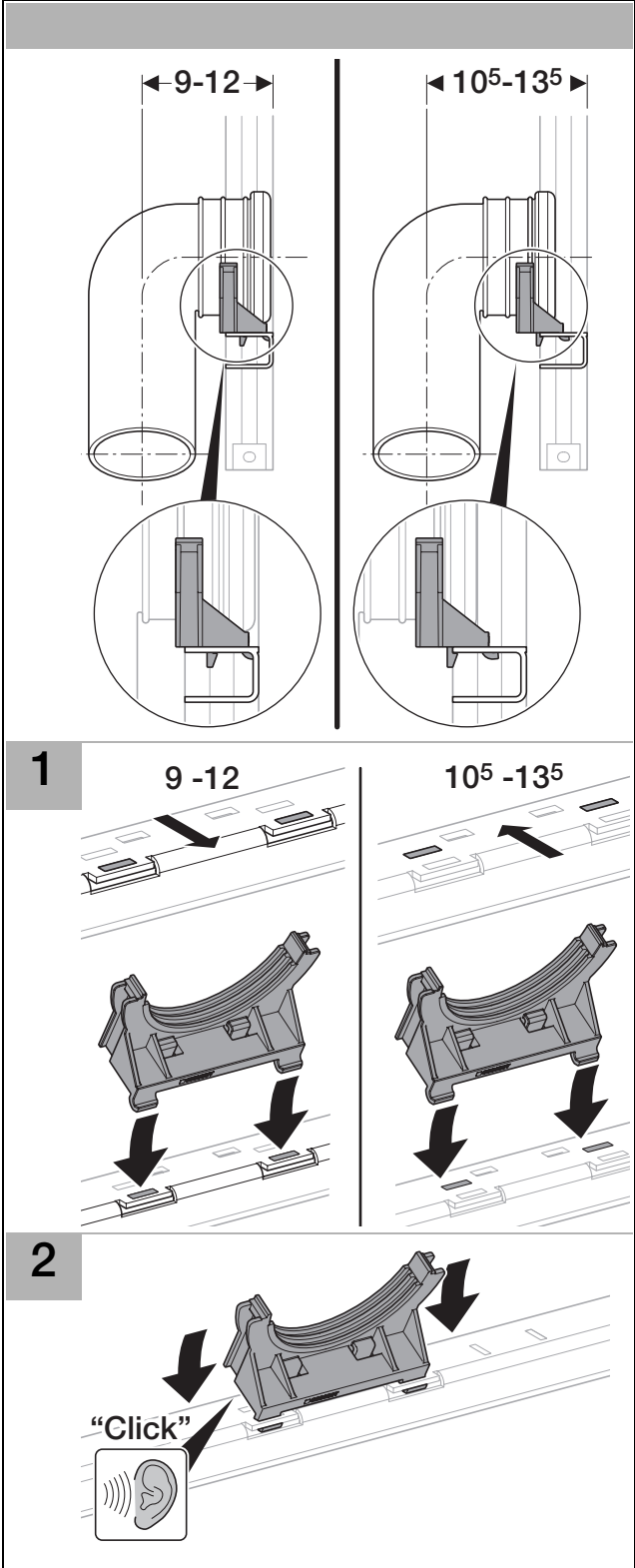

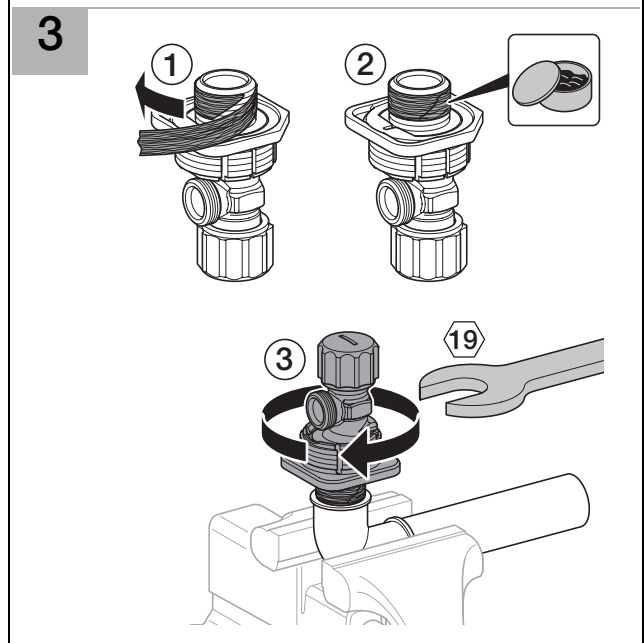
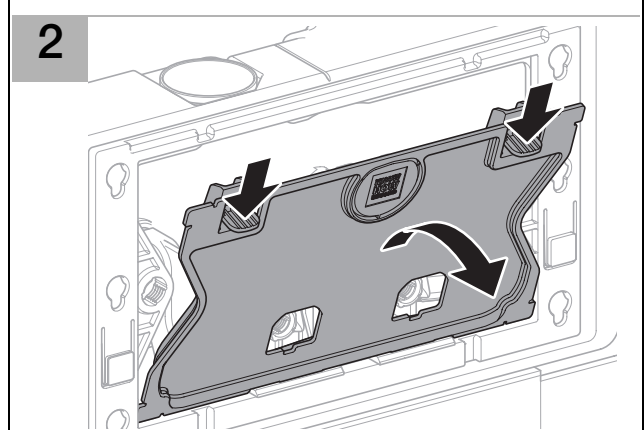
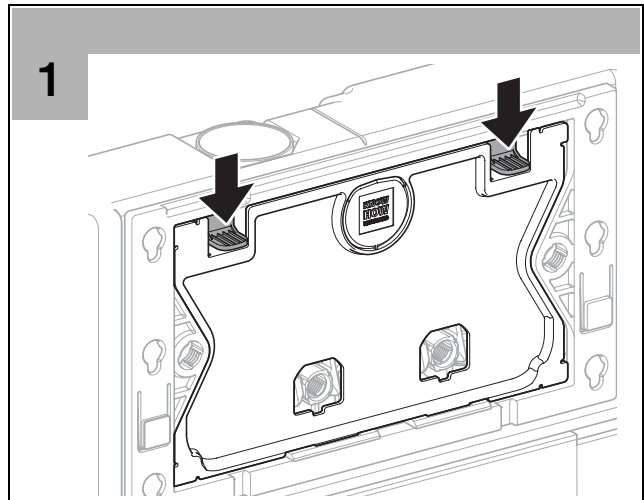
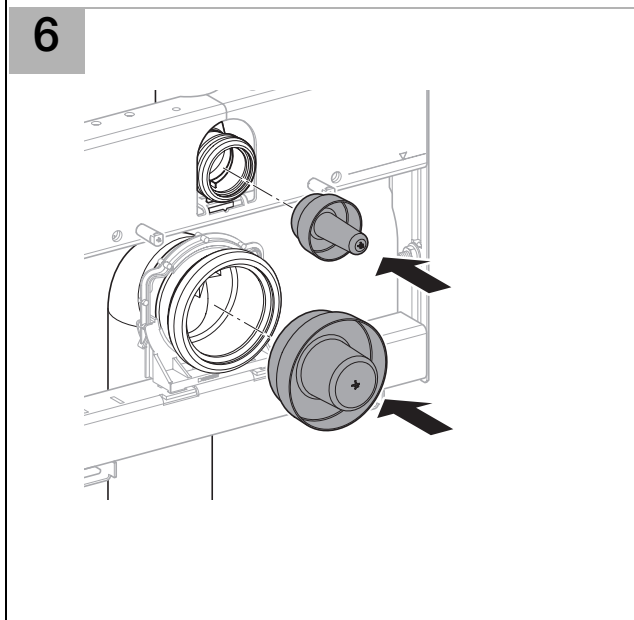
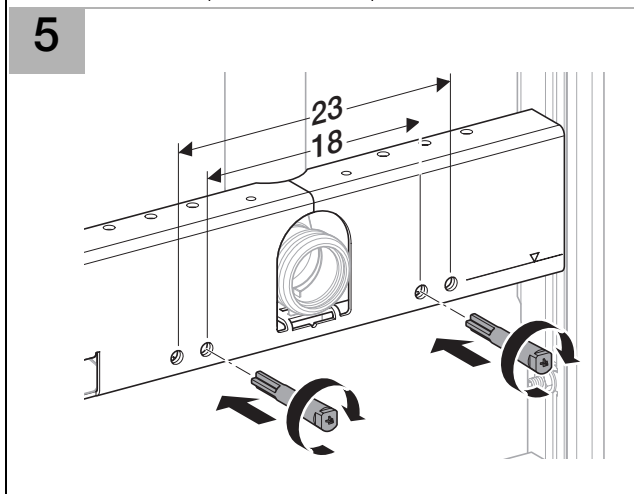
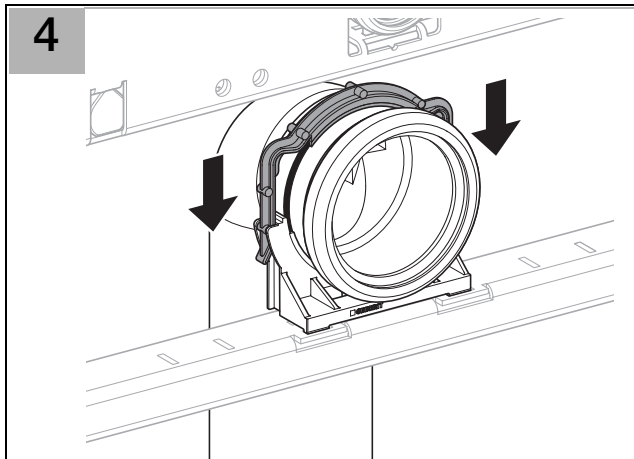

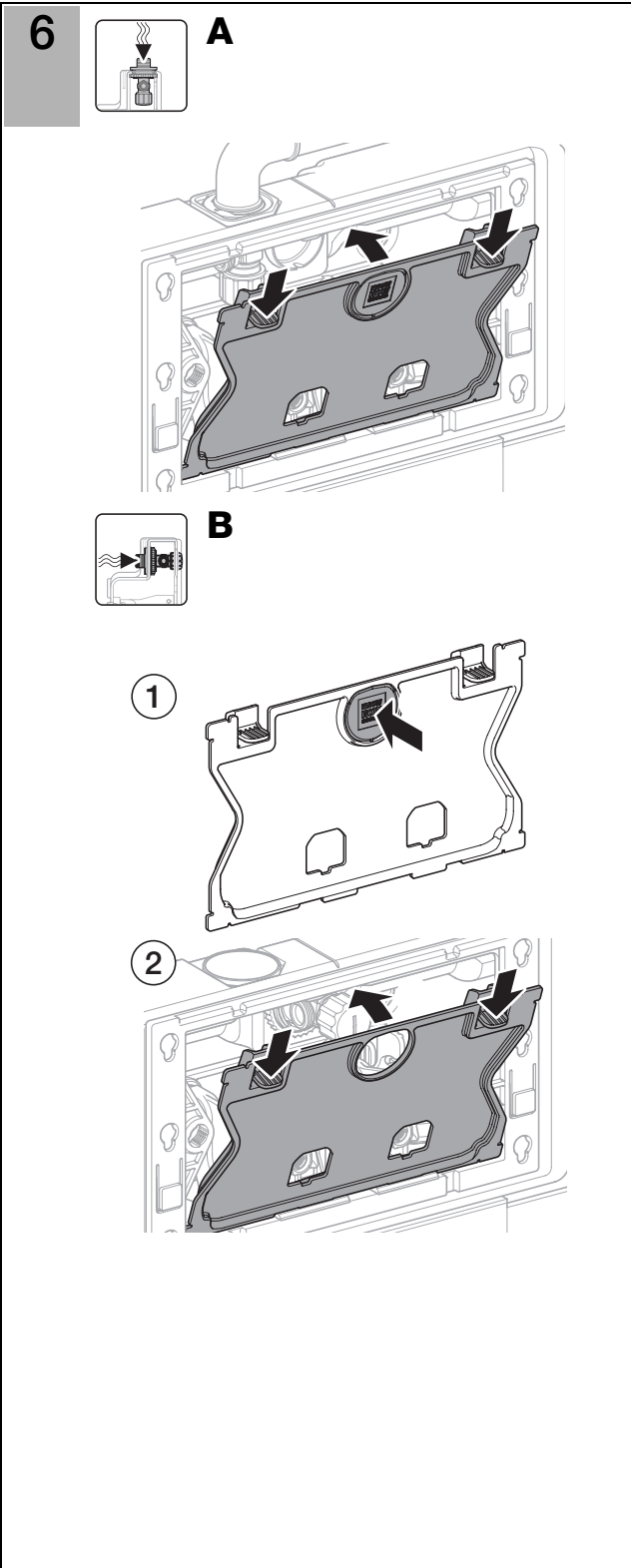
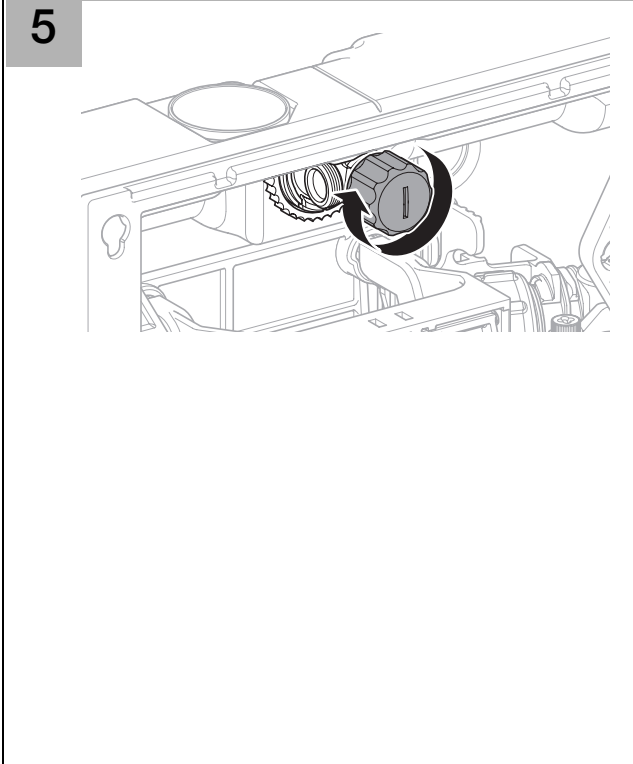
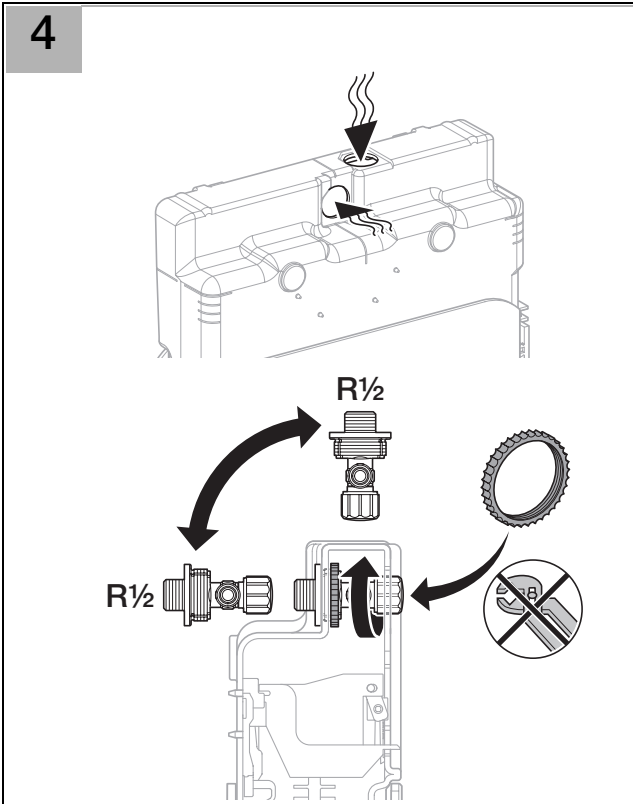

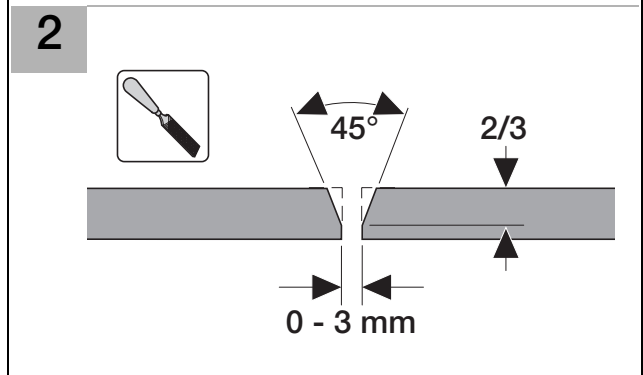
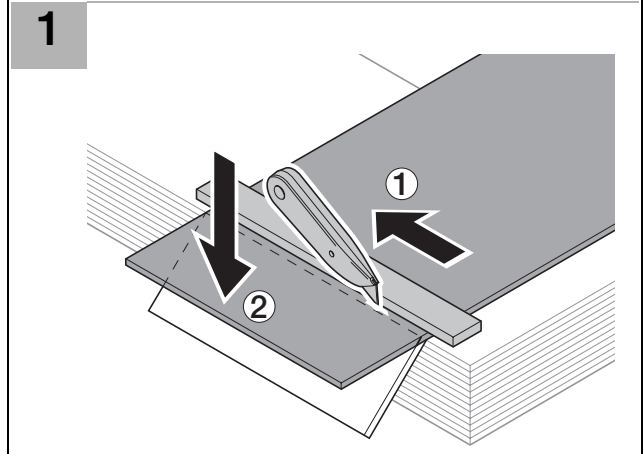
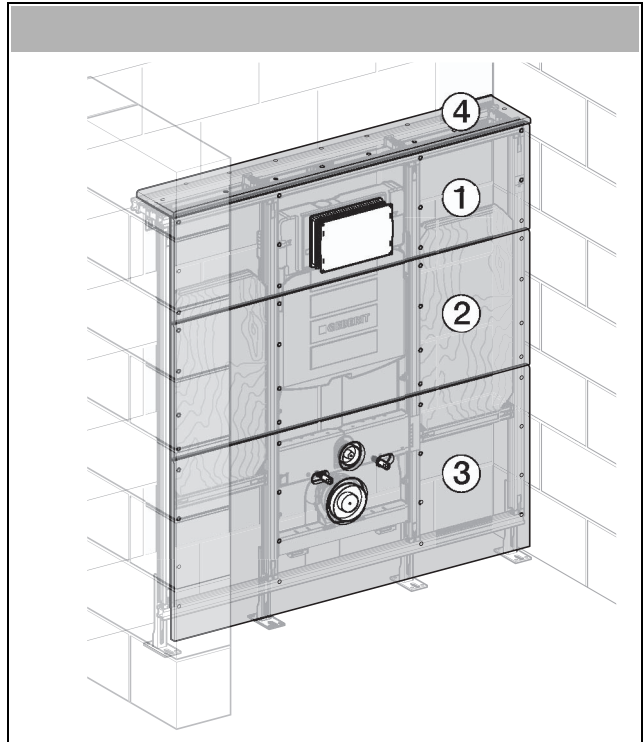
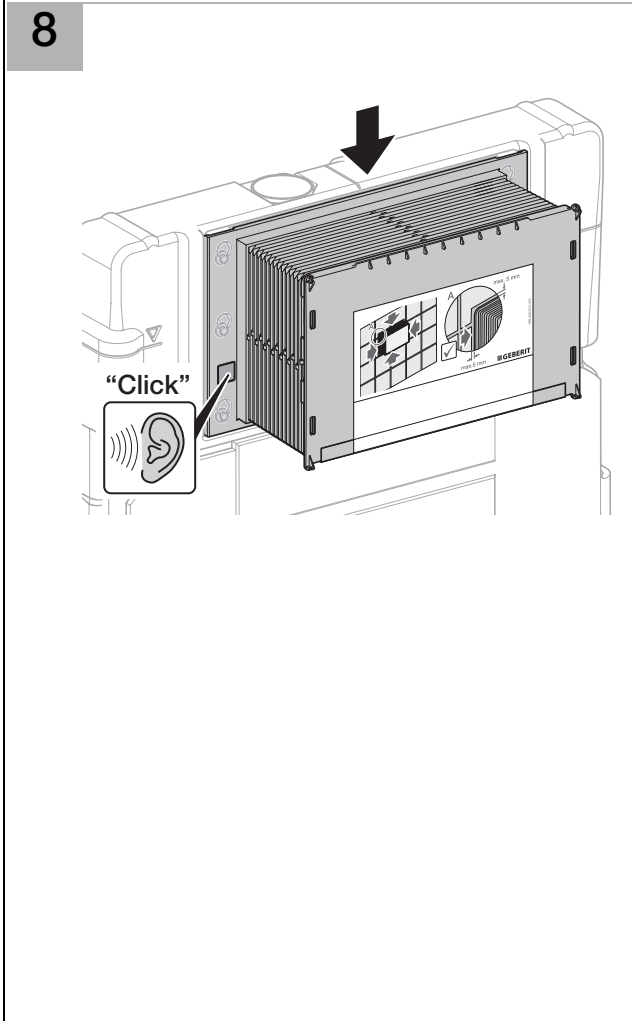
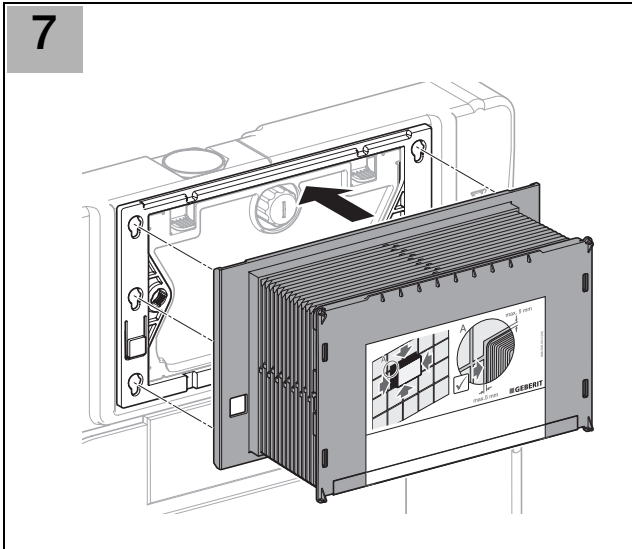

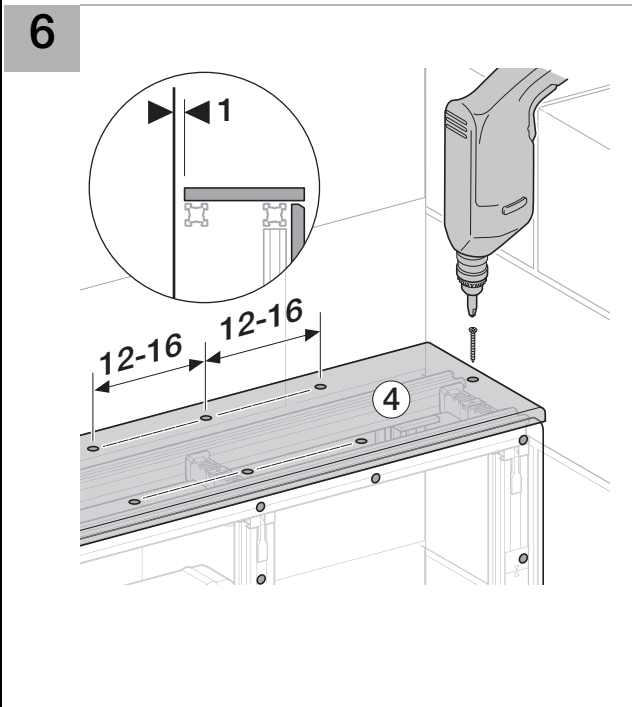
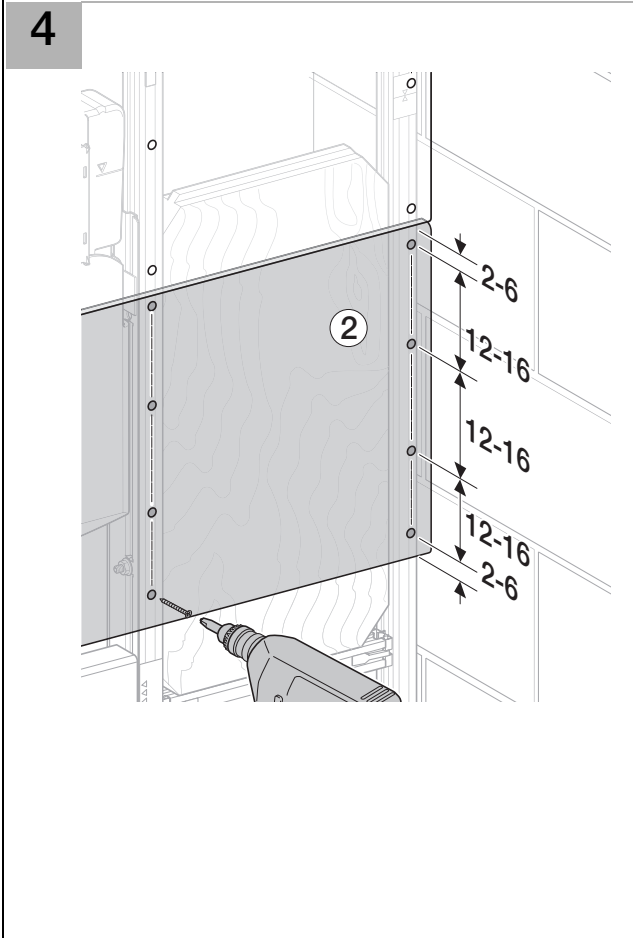
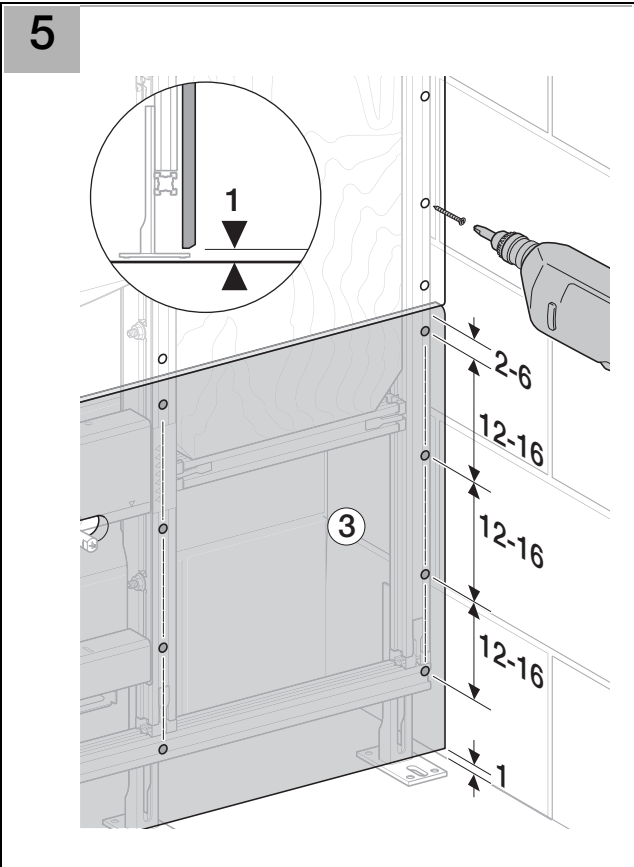
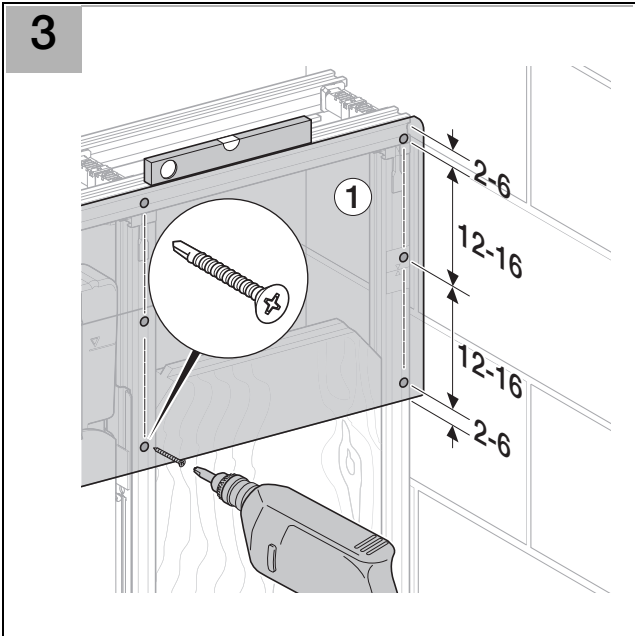

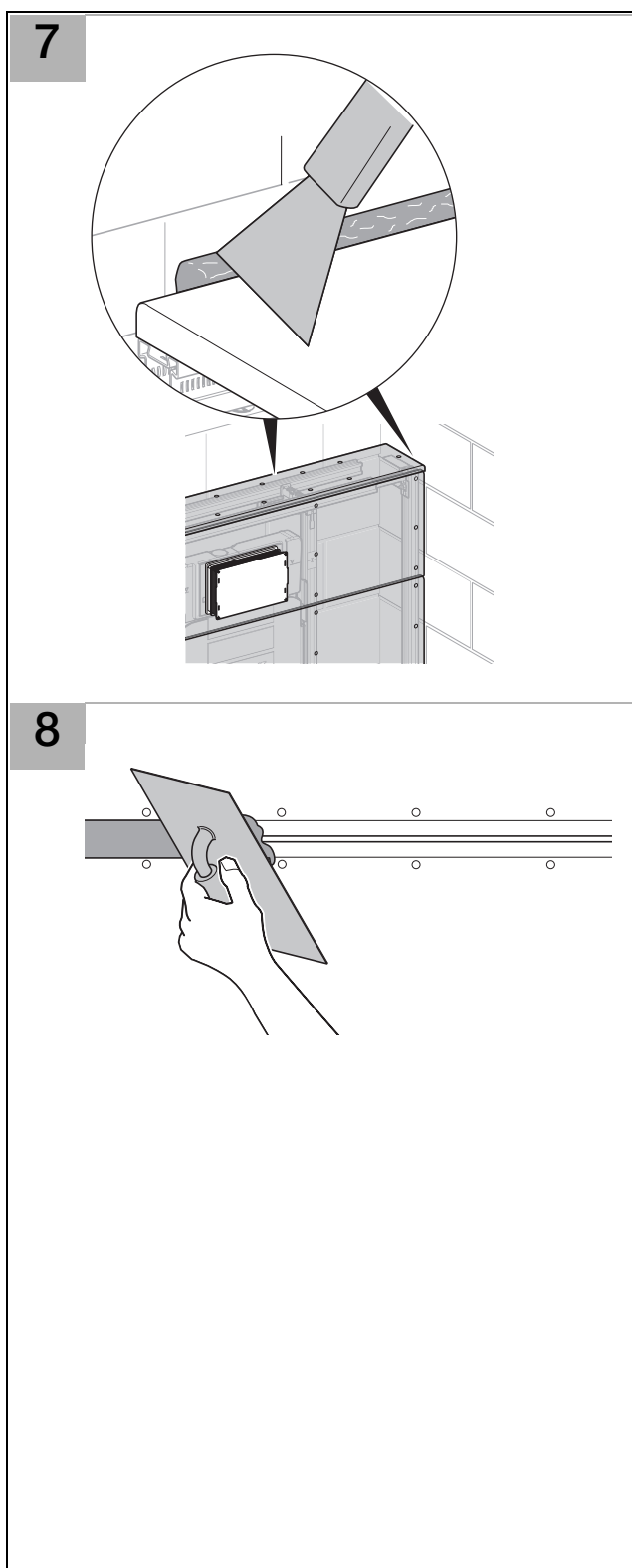

Geberit International AG
Schachenstrasse 77
CH-8645 Jona
www.geberit.com
dokumentation@geberit.com

D255628-001&BDC © 02-2008